

Catálogo de piezas y equivalencias 2020



Somos una empresa con 40 años de trayectoria en el medio, que proveemos todo tipo de juntas para motocicletas, motosierras y motoguadañas sean de fabricación nacional o importadas. Promoviendo la conservación del medio ambiente, hemos desarrollado materiales LIBRE DE ASBESTO (Amianto) que utilizamos en la fabricación de nuestras juntas, con calidad equivalente a los productos originales. Por nuestra capacidad instalada y la alta tecnología de punta, también proveemos juntas para usos industriales en formatos y materiales acorde a especificaciones de los clientes.

La más amplia variedad de Juntas, antiguas y nuevas.

ADLY	CICLON	GHIGGERI	KEEWAY	MURAVEY	SACHS
ALPINO	CLOVERY BOLD	GILERA	KELLER	NANFANG	SAFARI
APPIA	CORBIKE	GUERRERO	KINETIC	NSU	SALATINO
ATALA	CORVEN	GUZZI	KIRDI	OKINOI	SANYANG
ATV	DA DALT	HERCHEE	KONISA	PANTHER	SCOUT
AVANTI	DAELIM	HERO PUCH	KTM	PETERSON	SIAMBRETTA
AX SAP	DAYAMA	HONDA	KYMCO	PEUGEOT	SOMEX
BACCIO	DEI	HUSKY	LEGNANO	PGO	SUMO
BAJAJ	DEL VISO	HUSQVARNA	LH	PIAGGIO	SUNNY
BETA	DKW	HYOSUNG	LIMING	POLINI	SUZUKI
BLACKSTONE	DUCATTI	IMSA	MAGISTER	POWER	TIBO
BLASTER	DYNAMIC	ISO	MAVERICK	PUMITA	TVS
BONNY	FENCOR	JAWA	MELIPAL	Q. AX	VESPA
BONUS	FENG TONG	JIALING	METRA	Q. JIAM	YAMAHA
BRAVA	FRAMBRETTA	JIANSHE	MINKS	QINGQI	ZADINA
BRN	FX-TOP	JINCHENG	MODENAS	RAFTER	ZANELLA
CAGIVA AGRALE	GAMMA	JUKI	MONDIAL	RIZZATO	
CAHUEL	GARELLI	KAWASAKI	MORINI	RPA	
GERRO	GD	KAYAK	MOTOMEL	RUMI	



INDICE



Descripción	Pág.
Exhibidores	6
Tacos Goma Maza	8
Varios	9
Retenes	10
Tapas y Bases en Cobre	11
Bases en Alma de Metal	11
Tear Off´s	12
Tapas de Válvulas	14
Cubas de Carburador	15
Tapas de Cil. Cuatriciclos	15
Tapas de Cil. Motos	17
Motos y Cuatriciclos	26

INDICE - Motos y Cuatriciclos

Marca	Modelo	Pág.
APPIA	110 ANDINA (Ø54 - CAD.75 MM - P.A.RED.)	44
APPIA	110 CITI PLUS (Ø54-CAD.75 MM - P.A.RED.)	44
APPIA	110 DCN (Ø54 - CAD. 83 MM - P.A.OVAL.)	52
APPIA	110 VECTRA (Ø54 - CAD. 83 MM - P.A.OVAL.)	52
APPIA	125 BERAKA	46
APPIA	125 GEREY	46
APPIA	150 BLESS	27
APPIA	150 BREZZA (BAL.)	26
APPIA	150 BREZZA EURO	68
APPIA	150 MONTERO (M.VJO)	27
APPIA	150 MONTERO M.08/09	27
APPIA	150 MONTERO M.N. (VAR.BAL)	26
APPIA	150 STRONGER	26
APPIA	200 HARDWING	94
APPIA	200 SL	94
ATV	200 WATER COOLER	98
AX SAP	100	102
BAJAJ	100 2T.	102
BAJAJ	125 XCD (STREET)	28
BAJAJ	135 ROUSER	29
BAJAJ	150 BOXER	30
BAJAJ	150 NS	32
BAJAJ	150 ROUSER	31
BAJAJ	150 V 15	33
BAJAJ	160 ROUSER NS	34
BAJAJ	180 ROUSER	35
BAJAJ	200 ROUSER	36
BAJAJ	200 ROUSER NS	37
BAJAJ	400 D DOMINAR	38
BENELLI	150 TNT -15	39
BETA	110 BS (Ø54 - CAD.75 MM - P.A.RED.)	44

Marca	Modelo	Pág.
BETA	110 URBA (Ø54 - CAD.75 MM - P.A.RED.)	44
BETA	150 AKVO	40
BETA	150 BK	54
BETA	200 MOTARD	41
BETA	300 EURO	42
BLACKSTONE	300 MX (4 VALV.)	83
BRAVA	110 ALPINA (Ø54 - CAD.75 MM - P.A.RED.)	44
BRAVA	110 APOLO (Ø54 - CAD.75 MM - P.A.RED.)	44
BRAVA	110 NEVADA (Ø54 - CAD.75 MM - P.A.RED.)	44
BRAVA	125 ATHENE	46
BRAVA	150 ELEKTRA	118
BRAVA	150 WINSTAR	92
BRAVA	200 (VAR. BAL.)	96
CERRO	110 BIX (Ø54 - CAD.75 MM - P.A.RED.)	44
CERRO	110 FLY (Ø54 - CAD.75 MM - P.A.RED.)	44
CERRO	110 LINK (Ø54 - CAD.75 MM - P.A.RED.)	44
CERRO	125 R9	92
CERRO	125 STREET	88
CERRO	150 CE (VAR.)	91
CERRO	150 PRINCE (CAD.)	54
CERRO	150 PRINCE (VAR.)	91
CERRO	150 STREET	118
CERRO	200 COLT (CAD.)	93
CERRO	200 COLT (VAR.)	94
CERRO	200 SCRATCH	94
CERRO	250 (CUATRICICLO)	93
CERRO	250 PRINCE	122
CORVEN	110 ENERGY (Ø54 - CAD.75 MM - P.A.RED.)	44
CORVEN	110 MIRAGE (Ø54 - CAD.75 MM - P.A.RED.)	44
CORVEN	150 HUNTER	118
CORVEN	150 TRIAX	118



INDICE - Motos y Cuatriciclos

Marca	Modelo	Pág.
CORVEN	200 MOTARD (VAR. BAL.)	96
CORVEN	200 TRIAX R3 (BARL.)	96
CORVEN	250 TOURING	57
CORVEN	250 TRIAX R3 (BARL.)	96
CORVEN	256 INDIANA	122
DA-DALT	100 2T.	102
DA-DALT	110 DS (Ø54 - CAD.75 MM - P.A.RED.)	44
DAYAMA	200 DINO	43
DAYAMA	250 PARRILLERA	121
DYNAMIC	250 TERRA II	121
GAMMA	200 ADVENTURE	101
GAMMA	250 EVER GREEN	121
GILERA	100 AX	102
GILERA	100 QM -9	59
GILERA	110 C DLX (Ø54 - CAD.75 MM - P.A.RED.)	44
GILERA	110 ESTILO (Ø54 - CAD.75 MM - P.A.RED.)	44
GILERA	110 FUTURA (Ø54 - CAD.75 MM - P.A.RED.)	44
GILERA	110 GLA (Ø54 - CAD.75 MM - P.A.RED.)	44
GILERA	110 SMAH (Ø54 - CAD. 83 MM - P.A.OVAL.)	52
GILERA	110 SMASH (Ø54 - CAD.75 MM - P.A.RED.)	44
GILERA	110 SMASH (Ø54 - CAD.83 MM - P.A.RED.)	45
GILERA	125 FX (Ø54 - CAD. 83 MM - P.A.OVAL.)	52
GILERA	125 GA	66
GILERA	125 REVOLUTION (P.A.RED.)	46
GILERA	125 VC F/D	90
GILERA	150 GA	91
GILERA	150 VC STRADA (VAR.)	118
GILERA	150 YL (CUSTOM BAL.)	47
GILERA	200 SAHEL (VAR. BAL. CORTO)	48
GILERA	200 SAHEL (VAR. BAL. LARGO)	56
GILERA	200 SMX (VAR. BAL. CORTO)	48
GILERA	200 SMX (VAR. BAL. LARGO)	56
GILERA	200 VARILLERA	94
GILERA	200 VC (VAR. BAL. CORTO)	48
GILERA	200 VCR (CAD. BAL.)	49
GILERA	200 VCR (VAR. BAL.)	96
GILERA	200 YL (CHOPERA)	94
GILERA	250 CUSTOM	122
GILERA	250 RR-15	83
GILERA	250 VCR	122
GILERA	275 YL	122
GILERA	300 G1 RR	83
GILERA	400 SMX	50
GUERRERO	100 G	59
GUERRERO	100 GD	58
GUERRERO	100 MB	102
GUERRERO	100 WG BIKE	59
GUERRERO	110 BIKE (Ø54 - CAD.75 MM - P.A.RED.)	44
GUERRERO	110 DAY	114
GUERRERO	110 FLASH (Ø54 - CAD. 83 MM - P.A.OVAL.)	52
GUERRERO	110 FLASH (Ø54 - CAD.75 MM - P.A.RED.)	44
GUERRERO	110 FLASH (Ø54 - CAD.83 MM - P.A.RED.)	45
GUERRERO	110 FUTURE (Ø54 - CAD.75 MM - P.A.RED.)	44
GUERRERO	110 G DL (Ø54 - CAD.75 MM - P.A.RED.)	44
GUERRERO	110 GN KEOKEN (Ø54-CAD.75-P.A.RED.)	44
GUERRERO	110 GW WARRIOR (Ø54-CAD.75-P.A.RED.)	44
GUERRERO	110 TRIP (Ø54 - CAD. 83 MM - P.A.OVAL.)	52
GUERRERO	110 TRIP (Ø54 - CAD.75 MM - P.A.RED.)	44
GUERRERO	110 TRIP (Ø54 - CAD.83 MM - P.A.RED.)	45
GUERRERO	125 GC	66
GUERRERO	150 GLS ANDIAMO	53
GUERRERO	150 GMX (CUSTOM)	54

Marca	Modelo	Pág.
GUERRERO	150 KRYON	92
GUERRERO	200 GMX MOTARD (BAL.)	56
GUERRERO	200 GR1	55
GUERRERO	200 TUNDRA (BAL.)	56
GUERRERO	200 TUNDRA (CAD.)	93
GUERRERO	200 TUNDRA (VAR.)	94
GUERRERO	200 TUNDRA GXR (VAR. BAL. CORTO)	48
GUERRERO	230 GR5	55
GUERRERO	250 GMX (CUSTOM)	122
GUERRERO	250 GRF (M.2012)	57
GUERRERO	250 GXR TUNDRA	79
GUERRERO	70 FUTURE A/ELECT.	51
GUERRERO	70 G A/ELECT.	51
HONDA	100 C BIZ	58
HONDA	100 HERO CD	59
HONDA	100 WAVE NF	58
HONDA	105 BIZ (Ø54 - CAD.75 MM - P.A.RED.)	44
HONDA	110 WAVE S	60
HONDA	125 BIZ KS/ES M.2005	62
HONDA	125 BROSS	65
HONDA	125 CB F TWISTER	61
HONDA	125 CB1	61
HONDA	125 ELITE M.2014	63
HONDA	125 FAN	65
HONDA	125 STORM	64
HONDA	125 TITAN M.2000	65
HONDA	125 TODAY	66
HONDA	125 XLR	66
HONDA	125 XR L M.2013	67
HONDA	125 XR M.2012	64
HONDA	125 XR R M.2013	67
HONDA	150 AERO CBX	69
HONDA	150 CG TITAN	68
HONDA	150 INVICTA CB	68
HONDA	150 NX	69
HONDA	150 XR	68
HONDA	190 CB	70
HONDA	190 XR L (NUEVA)	70
HONDA	200 CG (VAR.)	94
HONDA	200 NX (BRASIL)	72
HONDA	200 NX (JAPON)	71
HONDA	200 STRADA CBX (BRASIL)	72
HONDA	200 STRADA CBX (JAPON)	71
HONDA	200 XR (BRASIL)	72
HONDA	200 XR (JAPON)	71
HONDA	250 CB TWISTER 2018/19 INY.	73
HONDA	250 CBX TWISTER	75
HONDA	250 CR M.2006	74
HONDA	250 TORNADO	75
HONDA	300 XRE RALLY	76
HONDA	400 NX FALCON	77
HONDA	400 NX FALCON M.'99	77
HONDA	400 XR (TODOS LOS MODELOS)	77
HONDA	600 CBR F1-F2-F3	78
IMSA	110 TRACK EVO (Ø54 - CAD.75 - P.A.RED.)	44
IMSA	150 ROAD	91
JAWA	250 RVM TEKKEK	79
JAWA	300 6 (SIN BAL.)	80
JAWA	300 9 (SIN BAL.)	80
JAWA	300 E (SIN BAL.)	80
JAWA	350 9 (CON BAL.)	82
JAWA	350 9 (SIN BAL.)	81

INDICE - Motos y Cuatriciclos



Marca	Modelo	Pág.
JAWA	350 BOBBER (CON BAL.)	82
JAWA	350 BOBBER (SIN BAL.)	81
JAWA	350 DAYTONA (CON BAL.)	82
JAWA	350 DAYTONA (SIN BAL.)	81
JAWA	350 RUTA 40 (CON BAL.)	82
JAWA	350 RUTA 40 (SIN BAL.)	81
JAWA	350 SPYDER (CON BAL.)	82
JAWA	350 SPYDER (SIN BAL.)	81
JIANSHE	125 F (CUB)	107
JIANSHE	125 JS 6B STREET M.2011/13	108
JIANSHE	125 M.N.	108
KAYAC	250	57
KAYAC	150	54
KEEWAY	150 RKS	104
KELLER	110 BIG (Ø54 - CAD.75 MM - P.A.RED.)	44
KELLER	110 CRONO CLASSIC (Ø54 -CAD.75-P.A.RED.)	44
KELLER	110 TITAN (Ø54 - CAD.75 MM - P.A.RED.)	44
KELLER	125 CRONO TRIAL	46
KELLER	150 CONQUISTAR	92
KELLER	150 E-XTREME	92
KELLER	150 KN STRATUS	118
KELLER	200 MIRACLE	94
KELLER	250 EXCELENCE	122
KELLER	250 QUAD RACER	98
KELLER	260 MX	83
KELLER	260 QUASAR	84
KELLER	260 R (HASTA M. 2013)	84
KELLER	260 RACING K2/NAKED (BAL.)	85
KELLER	260 STRATUS	84
KONISA	110 MAGNIFIKA (Ø54-CAD.75 MM-P.A.RED.)	44
KONISA	110 TUCUBIZ (Ø54 - CAD.75 MM - P.A.RED.)	44
KONISA	125 CITIZEN	46
KONISA	125 KONISTAR	46
KONISA	125 KONITOP	46
KONISA	125 LF	88
KTM	200 DUKE	86
KTM	390 DUKE	87
KYMCO	110 ACTIV (Ø54 - CAD.75 MM - P.A.RED.)	44
KYMCO	125 SECTOR	66
MAVERICK	110 H (Ø54 - CAD.75 MM - P.A.RED.)	44
MAVERICK	125 CITY (VAR.)	90
MAVERICK	125 SUPRA	46
MAVERICK	150 STREET	118
MAVERICK	200 DUAL MOTARD (BAL.)	56
MAVERICK	250 PANTHER	98
MONDIAL	256	98
MONDIAL	100 2T.	102
MONDIAL	110 LD (Ø54 - CAD.75 MM - P.A.RED.)	44
MONDIAL	110 LD 3 VALVULAS	115
MONDIAL	115 AX	102
MONDIAL	125 LD	46
MONDIAL	125 MD/HD	88
MONDIAL	125 RD (VAR.)	88
MONDIAL	150 EX K	89
MONDIAL	150 HD	91
MONDIAL	150 HD (SCOOTER)	92
MONDIAL	150 RD (VAR.)	91
MONDIAL	150 TD	91
MONDIAL	200 RD (VAR.)	94
MONDIAL	200 TD (BAL.)	56
MONDIAL	200 TD (VAR.)	94
MONDIAL	250 HD CUSTOM	122

Marca	Modelo	Pág.
MONDIAL	254 HD	122
MOTOMEL	100 AX	102
MOTOMEL	110 BIT (Ø54 - CAD.75 MM - P.A.RED.)	44
MOTOMEL	110 C DLX (Ø54 - CAD.75 MM - P.A.RED.)	44
MOTOMEL	110 CLIPPER (Ø54 - CAD.75 MM - P.A.RED.)	44
MOTOMEL	110 FD (Ø54 - CAD.75 MM - P.A.RED.)	44
MOTOMEL	110 MAX	114
MOTOMEL	125 BLITZ	46
MOTOMEL	125 CG	90
MOTOMEL	125 SKORPION	46
MOTOMEL	125 SL	92
MOTOMEL	125 TOP (CUBS)	46
MOTOMEL	125 TOP (VAR.)	90
MOTOMEL	125 X3M	90
MOTOMEL	150 CUSTOM (CAD.)	54
MOTOMEL	150 HD (VAR.)	91
MOTOMEL	150 SKUA (VAR.)	91
MOTOMEL	150 TCP (VAR.)	118
MOTOMEL	150 VX	92
MOTOMEL	200 CUSTOM (VAR.)	94
MOTOMEL	200 DAKAR (BAL.)	56
MOTOMEL	200 DAKAR (CAD.)	93
MOTOMEL	200 DAKAR (VAR.)	94
MOTOMEL	200 KS PISTERA (VAR. BAL.)	96
MOTOMEL	200 SIRIUS	95
MOTOMEL	200 SKUA (CAD. BAL.)	49
MOTOMEL	200 SKUA MOTARD (VAR. BAL. CORTO)	48
MOTOMEL	200 SKUA MOTARD (VAR. BAL. GRANDE)	96
MOTOMEL	200 SKUA MOTARD M.2010 (VAR. BAL.)	96
MOTOMEL	200 SR (CAD. BAL.)	93
MOTOMEL	200 SR (CAD.)	49
MOTOMEL	200 SR (VAR.)	94
MOTOMEL	200 TCP (CAD. BAL.)	49
MOTOMEL	250 HAWKER	122
MOTOMEL	250 MEGELLI (CAD.)	57
MOTOMEL	250 QUEST (PARRILERO)	121
MOTOMEL	250 RIDER	122
MOTOMEL	250 SKUA (VAR. BAL.)	96
MOTOMEL	250 TRACKER	122
MOTOMEL	250 VOLKANO	98
MOTOMEL	250 XMM (CAD. BAL.)	97
MOTOMEL	250 XMM (VAR. BAL.)	96
MOTOMEL	250 XPLORA	98
MOTOMEL	250 XPLORA (VAR. BAL.)	96
MOTOMEL	70 ECO A/ELECT.	51
NANFANG	100 JIMNA FN	59
OKINOI	125	46
OKINOI	150 NAKED	118
OKINOI	150 R	118
OKINOI	150 ST STREET	118
OKINOI	250 MOTARD	98
PANTHER	250	100
PANTHER	200 M.N.	99
PITBULL	200	101
Q. AX	100 CHINA	102
Q. JIAM	100	102
SCOUT	250 C MAX	98
SUMO	125 CG (VAR.)	90
SUMO	150 RAPID	118
SUMO	200 SL	94
SUMO	250 RINO	98
SUZUKI	100 AX	102



INDICE - Motos y Cuatriciclos

Marca	Modelo	Pág.
SUZUKI	115 AX	102
SUZUKI	125 AN	103
SUZUKI	125 EN	104
SUZUKI	150 GXR GIXXER	105
SUZUKI	160 GIXXER	105
VESPA	150 PHANTOM (SCOOTER)	92
YAMAHA	100 CRYPTON	106
YAMAHA	105 CRYPTON	106
YAMAHA	110 NEW CRYPTON	107
YAMAHA	125 XTZ	108
YAMAHA	125 YBR	108
YAMAHA	150 R15	109
YAMAHA	160 FZ 16	110
YAMAHA	250 XTZ	111
YAMAHA	250 YBR	111
YAMAHA	250 YS	111
YAMAHA	350 RAPTOR	112
YAMAHA	350 WARRIOR	112
YAMAHA	400 WR	113
YAMAHA	400 YZF	113
YAMAHA	426 YZF	113
ZANELLA	110 BUSUNESS	114
ZANELLA	110 DUE (Ø54 - CAD.75 MM - P.A.RED.)	44
ZANELLA	110 SEXY (Ø54 - CAD.75 MM - P.A.RED.)	44
ZANELLA	110 SWING (Ø54 - CAD.75 MM - P.A.RED.)	44
ZANELLA	110 VENTO 2V. (Ø54 - CAD.75-P.A.RED.)	44
ZANELLA	110 VENTO 3 VALVULAS	115
ZANELLA	110 ZB 2V. (Ø54 - CAD.75 MM - P.A.RED.)	44
ZANELLA	110 ZB 3 VALVULAS	115
ZANELLA	125 DUE	46
ZANELLA	125 HJ	65

Marca	Modelo	Pág.
ZANELLA	125 RACER	116
ZANELLA	125 RX M.NVO.	90
ZANELLA	125 SAPUCAI 4T.	90
ZANELLA	125 SEXY	46
ZANELLA	125 ZB	116
ZANELLA	125 ZSC	92
ZANELLA	150 CECATTO	117
ZANELLA	150 HJ	91
ZANELLA	150 PATAGONIA EAGLE BLACK METAL	89
ZANELLA	150 RX (CAD.)	69
ZANELLA	150 RX (VAR. BAL.)	47
ZANELLA	150 RX (VAR.)	118
ZANELLA	200 RX (VAR.)	94
ZANELLA	200 RX NAKED (BAL.)	56
ZANELLA	200 Z MAX TRUCK	119
ZANELLA	200 ZR 200 OHC	120
ZANELLA	200 ZTT (VAR.)	94
ZANELLA	250 FX SCORPION	98
ZANELLA	250 G FORCE (M.N.)	121
ZANELLA	250 PATAGONIA EAGLE (CUSTOM)	122
ZANELLA	250 STYLER	123
ZANELLA	250 ZR GTA	124
ZANELLA	300 FX MAD MAX	83
ZANELLA	350 CHOPPER	82
ZANELLA	350 RX NAKED	82
ZANELLA	350 RZ 35R	82
ZANELLA	400 FX	112
ZANELLA	70 TRICARGO	51

EXHIBIDORES

JUNTAS TAPA DE VÁLVULAS

9808

Incluye!!

10 c/u

- Yamaha FZ 16
- Honda CG 150
- Appia Brezza 150

Incluye!!

5 c/u

- Honda Tornado 250
- Honda Wave 110



JUNTAS TAPA DE VÁLVULAS

9810

Incluye!!

10 c/u

- Honda Today 125
- Honda CB1 125

Incluye!!

5 c/u

- Honda CB 250
- Bajaj Rouser 135
- Bajaj NS 200



9800

66 medidad diferentes
Color NEGRO

Serie Standard

1,78 mm
2,62 mm
3,53 mm



En Cilindro Honda Biz y otras

12-7485 - Canal Aceite Tapa Cil. (18,5 x 14,5 mm)
12-7486 - Canal Aceite Base Cil.
12-7487 - Canal Aceite Tapa Cil. (12 x 9 mm)

Cubas de Carburador

12-7547 - Ciclomotor Etc...
12-7544 - Honda Wave 100 Etc.
12-7593 - Honda Econo/Biz - Smash Etc.
12-7633 - Honda Today/Titan 125 Etc.

9804

- Honda Elite LX 50
- Honda Elite CH 150
- Honda Kinetic 100
- Honda NS 50
- Honda CB 650
- Honda MTX 125 / 200
- Bajaj Rouser NS 200
- Zanella JR 200
- Daelim 50 Liberty
- Mondial M1 50
- Suzuki AE 50
- Bajaj Rouser 150 a 200
- Za. Due/V3 50 (1,5 mm)
- Za. Due/V3 50 (3 mm)
- Mo. Pumita 50 (1,5 mm)
- Mo. Pumita 50 (3 mm)
- Ga. Noi/Team 50 (1,5 mm)
- Ga. Noi/Team 50 (3 mm)
- Za. Sol 50 (1,5 mm)
- Za. Sol 50 (3 mm)
- Za. Sol Plus 70 (1,5 mm)
- Za. Sol Plus 70 (3 mm)

Incluye!!
10 c/u

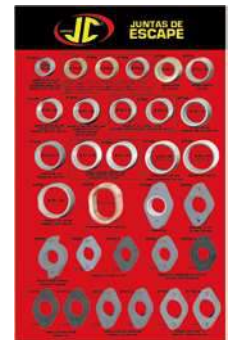

Incluye!!
30 c/u

- Gilera Smash 110 y otras

Incluye!!
20 c/u

- Honda CG/Today 125 y otras...

- Honda Tornado/Twister 250 y otras...

Incluye!!
5 c/u

- Kawasaki KLR 600/650

9802

Incluye!!
10 c/u



- Honda Dax 70
- Honda Econo C 90
- Honda Biz C 100
- Gilera Smash 110
- Appia Vectra 110
- Guerrero Flash 110
- Yamaha Crypton 100/105
- Honda Biz 125 KS/KE M.2005
- Gilera Revolution 125 P.A.Red.
- Gilera Revolution 125 P.A.Oval.

9806

Incluye!!
10 c/u



- Honda CG/Today 125
- Honda Titan/Storm/Fan/Bross 125
- Honda CB1 125
- Honda Wave 110
- Honda Titan 150
- Gilera Smash Revolution 125
- Potenciada de 110 c.c. a 125 c.c.
- Motomel Dakar 200 (Var.)
- Motomel Dakar 200 (Cad.)
- Motomel Dakar 200 (Bal.)/Tundra 200 (Bal.)



TACOS GOMA MAZA

12-7301

CAUCHO NATURAL



Paquete x 4

Honda
ECONO C90
Gilera
Smash 100/110
y otras...

12-7302

CAUCHO NATURAL



Paquete x 4

Honda
BIZ C 100/C 105
WAVE 100
y otras...

12-7303

CAUCHO NATURAL



Paquete x 4

Honda
STORM 125
Yamaha
V 80 / YBR 125
ZANELLA
RX 150 y otras...

12-7304

CAUCHO NATURAL



Appia
VECTRA 110
Suzuki
AX 100/115
y otras...

12-7305

CAUCHO NATURAL



Paquete x 4

Yamaha
CRYPTON
100/105
y otras...

12-7306

CAUCHO NATURAL



Bajaj
ROUSER 135
180/200/220
y otras...

12-7307

CAUCHO NATURAL



Paquete x 4

Honda
CG 150 TITAN
y otras...

12-7308

CAUCHO NATURAL



Paquete x 4

Honda
TWISTER 250

12-7309

CAUCHO NATURAL



Paquete x 4

Honda
- **BIZ 125 KS/ES**
M.2005
- **NEW WAVE 110**

SEGURO DE CORONA

**HONDA
ECONO C 90
BIZ 100/105
GILERA
SMASH 100/110
y otras...**

6500

Paquete
x10



SEGURO DE CORONA

**HONDA
STORM 125
YAMAHA
CRYPTON 100/105
y otras...**

6501

Paquete
x10



ESTIRA CADENA



- Ø 12
- Ø 14
- Ø 16
- Ø 18

11-0112

11-0114

11-0116

11-0118

11-0412

Cuatriciclo



- Ø 12

Paquete
x10

ARANDELA TAPON DE ACEITE

**HONDA
ECONO C90/WAVE
GILERA
SMASH
y otras...**

ALUMINIO
ESP. 1,5 mm

11-0212

11-0214

Paquete
x10

12x20

14x20



ARANDELA GUIA O RING

**HONDA
ECONO C90/WAVE
GILERA
SMASH
y otras...**

11-0303

METAL
ESP. 1,5 mm



Paquete
x10

GOMA MANUBRIO

**GILERA
SMASH
GUERRERO
TRIP
y otras...**

GOMA Y TELA
ESP. 2,5 mm

11-0301

14 x 30 mm



Paquete
x10

JUNTA UNION ESCAPE

- HONDA
- SUZUKI
- KAWASAKI
- YAMAHA
- Y OTRAS...

Resiste
1000 °C

11-0002

5 cm de ancho
Esp. 1,5 mm



TAPON TENSOR DIST. (FLAUTIN)

**HONDA
ECONO C90/BIZ/WAVE
GILERA
SMASH 100/110
y otras...**

11-0302

Paquete
x10



SELLA JUNTAS

CARACTERÍSTICAS GENERALES

Es un adhesivo sintético, de secado por evaporación y temperatura especial para juntas.
Actúa como sellador en las bombas de Agua, Cajas de Velocidad, Carter, Tapas de Distribución, Tapas de Válvulas, etc..
No es un cemento de contacto.
No tiene tolueno.
No se solidifica produciendo rajaduras y posibles pérdidas.
Al ser utilizado en juntas en donde se desarrollan temperaturas elevadas pega automáticamente sin cristalizar.

7181

Paquete
x12



SEP. ANTIRUIDO EN ENCARENADOS

- 6 X 15 mm
- 8 x 16 mm
- 10 x 18 mm

11-0206

11-0208

11-0210

Paquete
x50

Precio x Unidad

GOMA
ESP. 2,5 mm



RETEN ENCENDIDO

12-7201

**HONDA
TODAY
TITAN 125
Y OTRAS**



22 x 35 x 7 mm
NITRILO
DUREZA: 70 Shore

RETEN ENC. CHICO

12-7202

**HONDA
BIZ C 100
GILERA
SMASH 110
Y OTRAS**



18,9 x 30 x 5 mm
NITRILO
DUREZA: 70 Shore

RETEN ENC. GRANDE

12-7203

**HONDA
BIZ C 100
GILERA
SMASH 110
Y OTRAS**



30 x 42 x 4,5 mm
NITRILO
DUREZA: 70 Shore

KIT ENCENDIDO

9-637

**HONDA
TODAY
TITAN 125
Y OTRAS**



KIT ENCENDIDO

9-630

**HONDA
BIZ C 100
GILERA
SMASH 110
Y OTRAS**

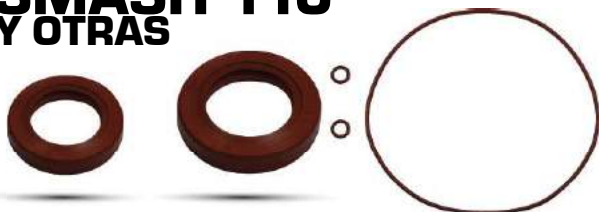

KIT O'RING TAPA DE CIL.

9-638

**HONDA
BIZ C 100
GILERA
SMASH 110
Y OTRAS**

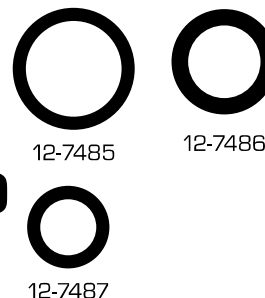

TAPAS y BASES en COBRE (COMPETICION)

Tapas y Bases de Cilindro en COBRE para

Motos tipo BIZ / SMASH / TITAN / RX 150 y otras...

Código - Material

(Código) **B - COBRE Esp. 0,1 mm**

(Código) **C - COBRE Esp. 0,2 mm**

(Código) **D - COBRE Esp. 0,3 mm**

(Código) **E - COBRE Esp. 0,4 mm**

(Código) **F - COBRE Esp. 0,5 mm**

Ej: Tapa cilindro Smash 110

07847 C - COBRE Esp. 0,2 mm



Bases de Cilindro - Material: Alma Metal

Sistema de sellado altamente efectivo consta de un soporte metálico revestido a ambos lados por material Premium.

Este metal ubicado en el alma de la junta ayuda a la tracción, compresión y recupero del material después del torque.

Metal



Material
Premium

Metal

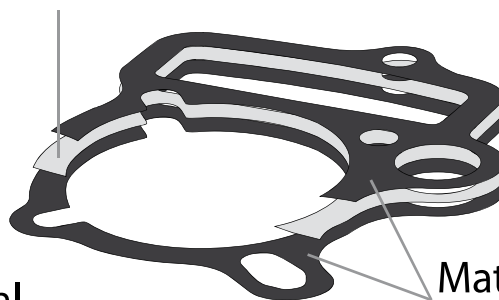

Material
Premium

Para pedir cualquier Base de Cilindro en este material solo debe agregar al número del código las letras "A/M"
Ej: **07846 A/M - BASE CIL. GILERA SMASH 110**



TEAR OFF'S

SCOTT (GRANDE)

149 mm

T07182

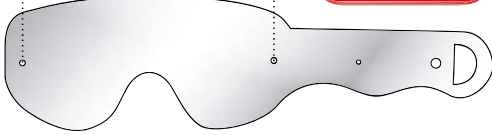

SCOTT (CHICO)

154 mm

T07183

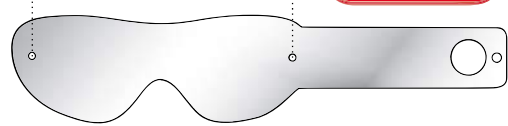

SCOTT QUICK LOAD

T07184

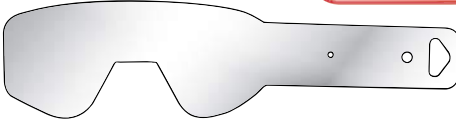

PROGRIP

148 mm

T07185

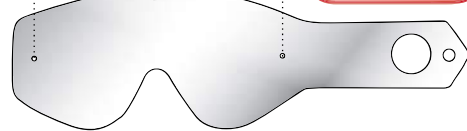

SMITH

154 mm

T07186

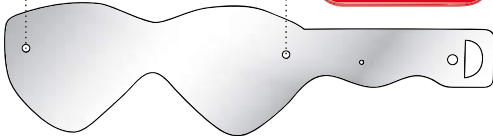

SPY

140 mm

T07187

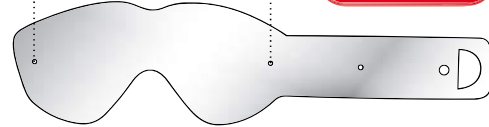

ARNETTE

157 mm

T07188

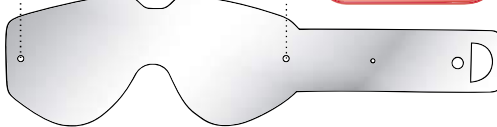

THOR

176 mm

T07189

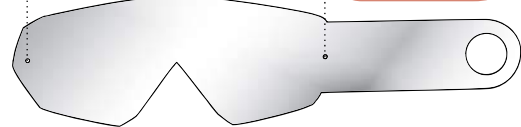

SCOTT 80 S

152 mm

T07190

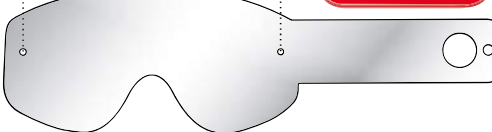

SCOTT VOLTAGE

152 mm

T07191

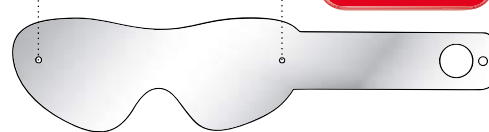

OAKLEY COWBAR

176 mm

T07192

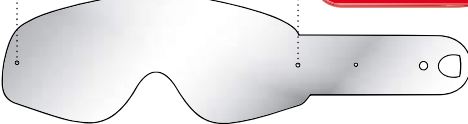

X - BRAND

170 mm

T07193

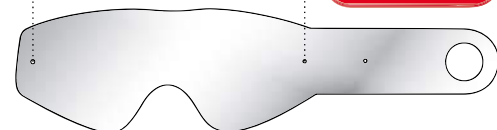

SCOTT SERIE 80 WORKS

155 mm

T07194

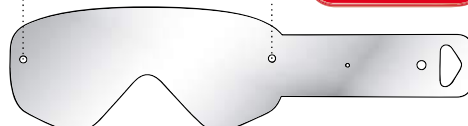

H VOLTAGE WORK

155 mm

T07195

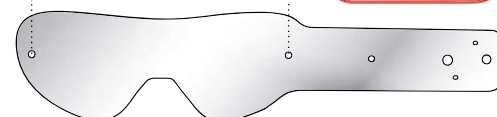

TEAR OFF'S



OAKLEY OFRAME

176 mm

T07196

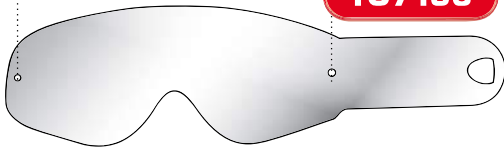

BRAND JUNIOR

150 mm

T07197

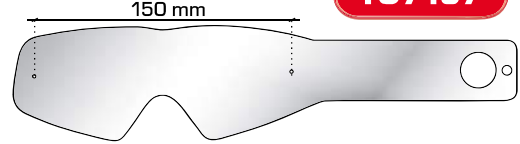

DRAGON MDX

176 mm

T07198

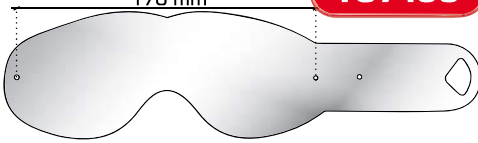

DRAGON VENDETTA

172 mm

T07199

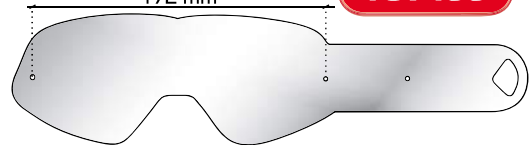

FOX X

169 mm

T07200

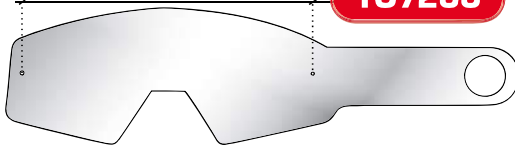

100 %

163 mm

T07201

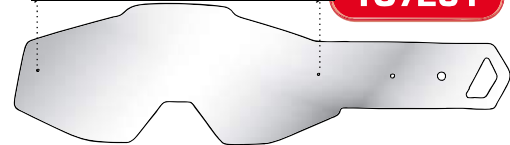

SLAYER PRO UTOPIA

165 mm

T07202

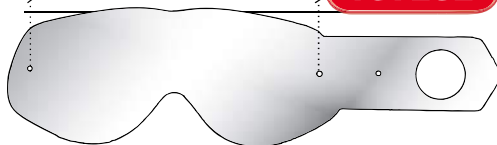

FOX M.N. AIR SPC

184 mm

T07203



SPY

170 mm

T07204

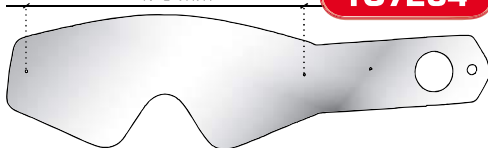

ARAI GP6

T07205



OAKLEY AIRBRAKE

160 mm

T07207

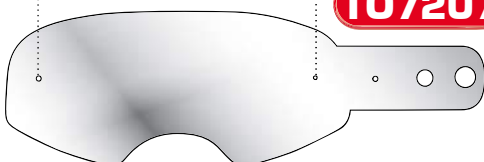

FLY

175 mm

T07208

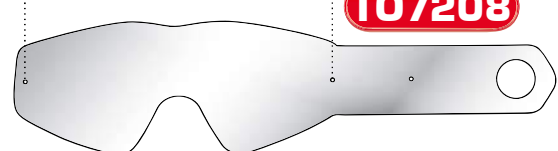

X BRAND 18 EKS-S

175 mm

T07209

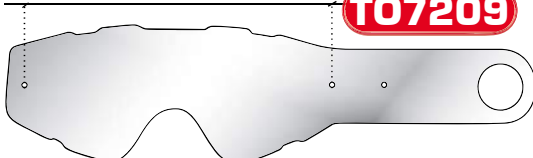



TAPAS DE VÁLVULAS

12-7545

HONDA
**CG/TODAY
TITAN 125
Y OTRAS...**

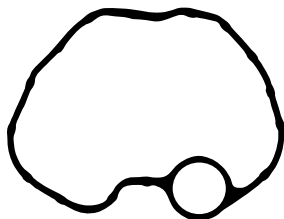

12-7750

APPIA
**BREZZA 150
Y OTRAS...**

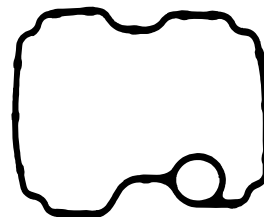

12-7650

HONDA
**CG 150 TITAN
Y OTRAS...**

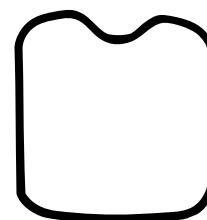

12-7751

HONDA
**CB 250
NIGHTWAWK
Y OTRAS...**

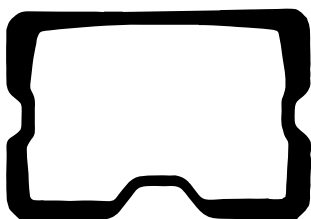

12-7752

YAMAHA
**FZ 16
Y OTRAS...**

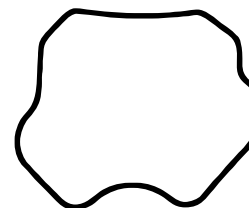

12-7753

HONDA
**TORNADO 250
TWISTER CBX 250
Y OTRAS...**

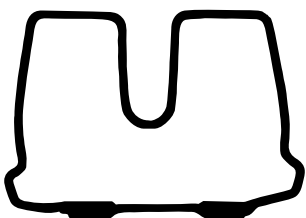

12-7754

HONDA
**CB 1 125
Y OTRAS...**

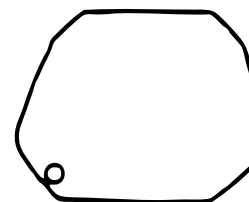

12-7755

HONDA
**WAVE 110
Y OTRAS...**

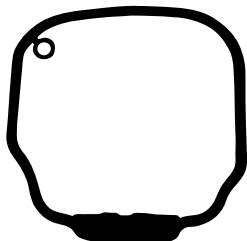

12-7756

BAJAJ
ROUSER 135

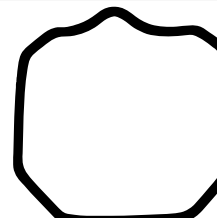

12-7757

BAJAJ
**ROUSER
200 NS**

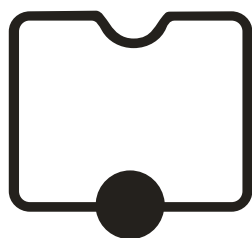

12-7758

HONDA
CB 190

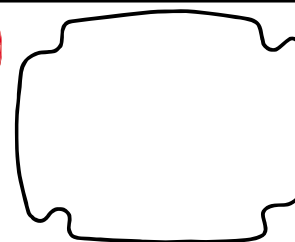

CUBAS DE CARBURADOR

CICLOMOTORES

12-7547



**HONDA
ECONO/BIZ/HERO
Y OTRAS...**

12-7593

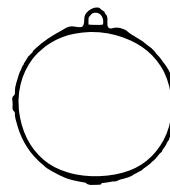

**HONDA
WAVE 100
Y OTRAS**

12-7544

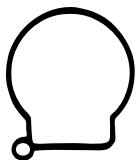

**HONDA
CG 125/TODAY
Y OTRAS...**

12-7633

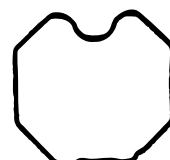

**BAJAJ
ROUSER 135
Y OTRAS**

12-7635

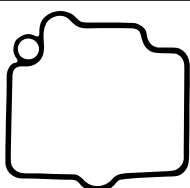

**HONDA
TORNADO 250
Y OTRAS**

12-7636

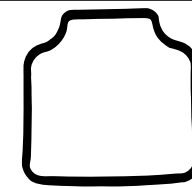

TAPA DISTRIBUCION

**HONDA
CB1 125**

12-7594

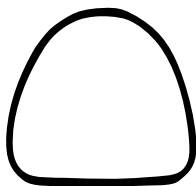

BOMBA DE AGUA

**BAJAJ
ROUSER 200 NS**

12-7595

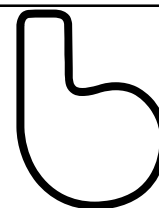

TAPAS DE CILINDRO - CUATRICICLOS

Gamma 200 M.N / 250 M.N.

24400 A

**MFT CON FONDO COBRE
ESP. 1,2 mm**

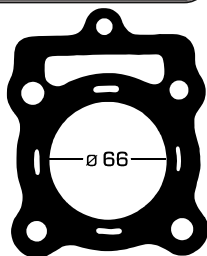

Gamma 200 / Motomel PITBULL 200

23548 M

METAL ESP. 0,22 mm

23548 A

MFT ESP. 1,2 mm

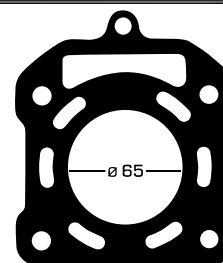

Guerrero 200 GSF-S MAPUCHE

23807 A

**MFT CON FONDO COBRE
ESP 1,2 mm**

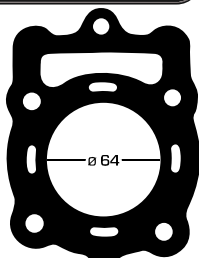

Motomel TRACKER 250

23892 A

MFT ESP. 1,20 mm

23892 M

METAL ESP. 0,22 mm

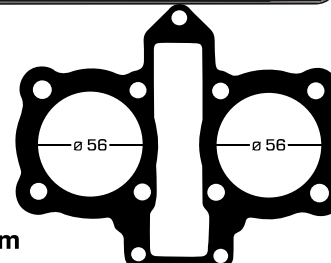



TAPAS DE CIL. - CUATRICICLOS

Panther 200

23797 M
METAL 3 LÁMINAS

23797 A
MFT ESP. 1,2 mm

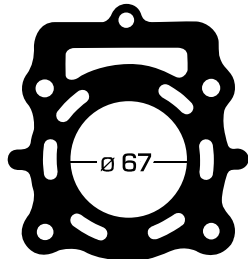

Panther 200 M.N.

23805 M
METAL ESP. 0,22 mm

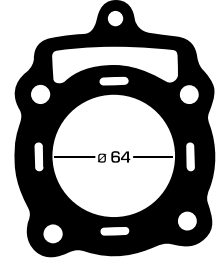

Panther 250

23782 M
METAL ESP. 0,22 mm

23782 A
MFT ESP. 1,2 mm

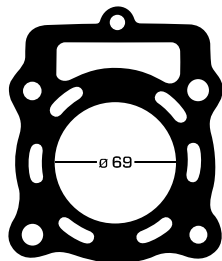

Rafter 200

23765 M
METAL 3 LÁMINAS

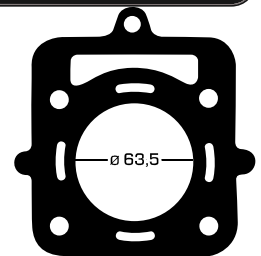

Yamaha YZF 450 R (Inyeccion) M.07/12

24484 M
Ø 96 - METAL 3 LÁMINAS

24485 M
Ø 99 - METAL 3 LÁMINAS

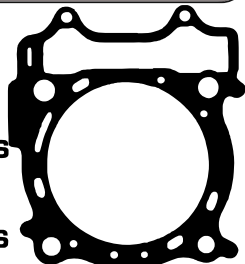

Zanella FX 200

23705 A
MFT C/FDO COBRE
ESP 1,2 mm

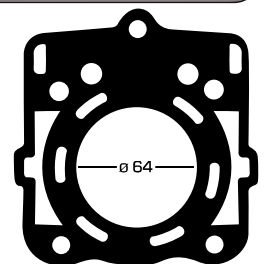

Zanella G-FORCE 250

23731 M
METAL 3 LÁMINAS

23731 A
MFT ESP. 1,2 mm

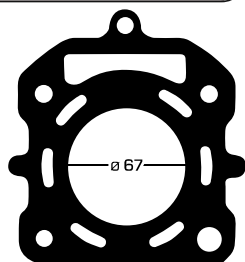

Zanella FX 250 SCORPION

23921 A
MFT ESP. 1,2 mm

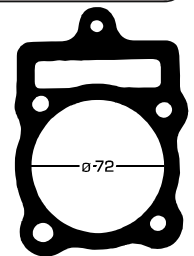

Zanella G-FORCE 250 M.N.

23958 M
METAL 3 LÁMINAS

23958 A
MFT ESP. 1,2 mm

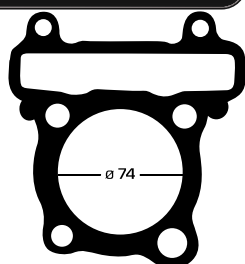

Za. FX 400/Ya. Raptor/Warrior 350

23957 M
METAL 3 LÁMINAS

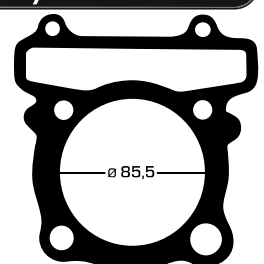

TAPAS CIL. MOTOS



Guerrero G 50 - Gilera C 50

02445 A

MFT ESP. 1,2 mm

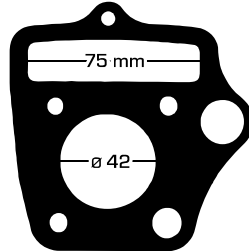

Honda Dax 70

01451 A

MFT ESP. 1,2 mm

01451 M

METAL 3 Láminas

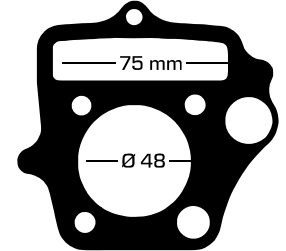

Honda ECONO C 90

01521 A

MFT ESP. 1,2 mm

01521 M

METAL 3 Láminas

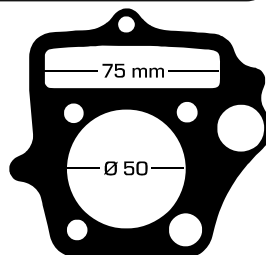

Honda BIZ C 100

01533 A

MFT ESP. 1,2 mm

01533 M

METAL 3 Láminas

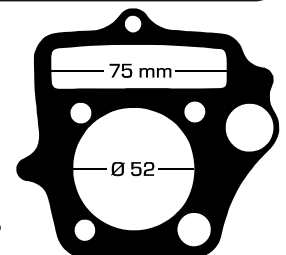

Gilera FUTURA 110 M.N.

08926 A

MFT ESP. 1,2 mm

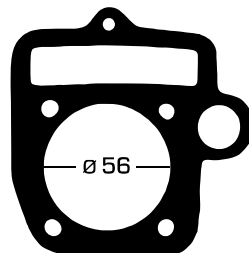

Gilera SMASH 110 ø 54 CAD. 75 P.A.RED.

07847 A

MFT ESP. 1,2 mm

07847 M

METAL 3 Láminas

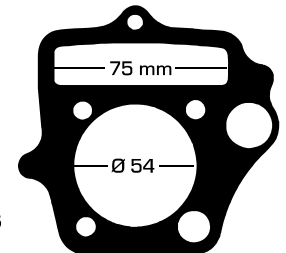

Gilera SMASH 110 ø 50 CAD. 75 P.A.RED.

24482 A

MFT ESP. 1,2 mm

24482 M

METAL 3 Láminas

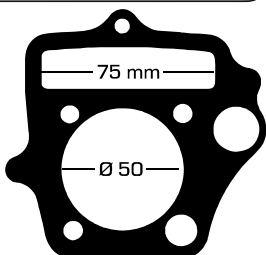

Gilera SMASH 110 ø 52 CAD. 75 P.A.RED.

24483 A

MFT ESP. 1,2 mm

24483 M

METAL 3 Láminas

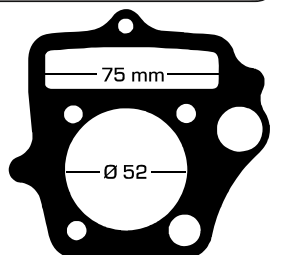

Gilera SMASH 110 ø 50 CAD. 83 P.A.RED.

24478 A

MFT ESP. 1,2 mm

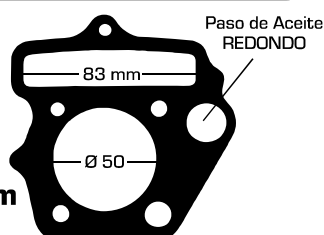

Gilera SMASH 110 ø 50 CAD. 83 P.A.OVAL.

24479 A

MFT ESP. 1,2 mm

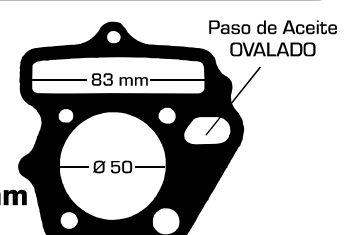



TAPAS CIL. MOTOS

Gilera SMASH 110 Ø 52 CAD. 83 P.A.RED.

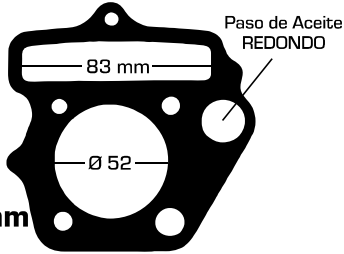

24480 A

MFT ESP. 1,2 mm

Gilera SMASH 110 Ø 52 CAD. 83 P.A.OVAL

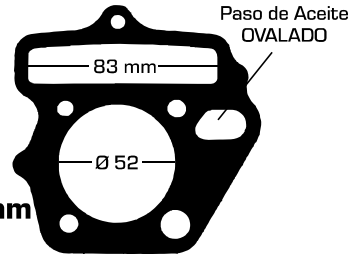

24481 A

MFT ESP. 1,2 mm

Guerrero TRIP 110 P.A.OVAL.

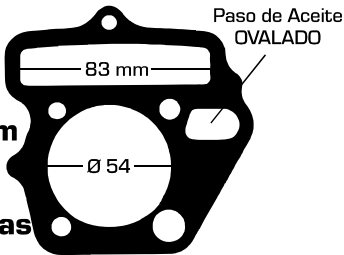

06650 A

MFT ESP. 1,2 mm

06650 M

METAL 3 Láminas

Guerrero TRIP 110 P.A.RED.

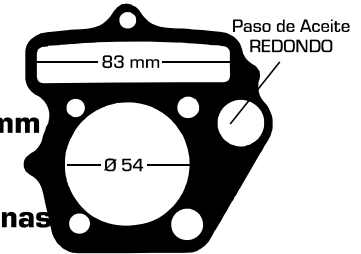

08865 A

MFT ESP. 1,2 mm

08865 M

METAL 3 Láminas

Potenciada de 110 a 125 c.c.

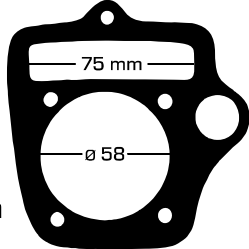

23750 A

MFT ESP. 1,2 mm

24518 M

METAL ESP. 0,22 mm

Gilera SMASH 110 Ø 56 Desp.

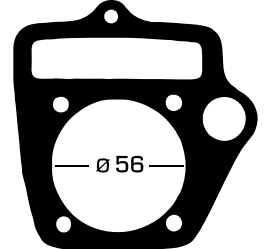

24518 A

MFT ESP. 1,2 mm

24518 M

METAL ESP. 0,22 mm

Bajaj XCD 125

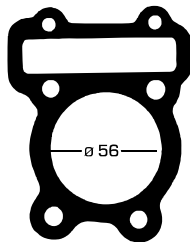

24002 M

METAL ESP. 0,22 mm

Bajaj ROUSER 135

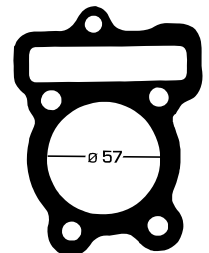

23994 M

METAL ESP. 0,22 mm

Bajaj ROUSER 150/180/200/220

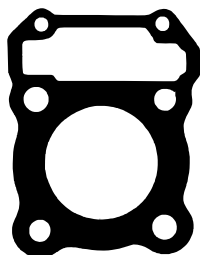

- 24010 M** ROUSER 150 - Ø60
- 24424 M** ROUSER 180 - Ø64
- 24017 M** ROUSER 200/220 - Ø68

Bajaj ROUSER 200 NS

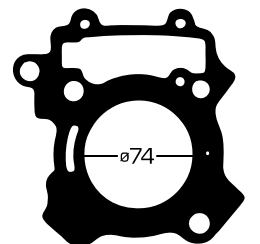

25193 M

METAL 3 Láminas

25193 A

MFT ESP. 1,2 MM

TAPAS CIL. MOTOS



Beta 200 MOTARD

24430 A

MFT ESP. 1,2 mm

24430 M

METAL 3 Láminas

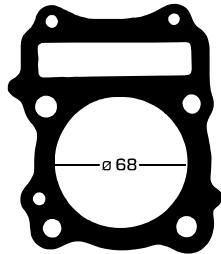

Corven EXPERT 80

25065 M

METAL ESP. 0,22 mm

25065 A

MFT ESP. 1,2 mm

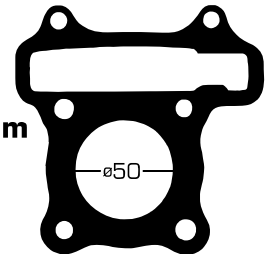

Gilera SUPER 125 M.N.

24038 M

METAL ESP. 0,22 mm

24038 A

MFT ESP. 1,2 mm

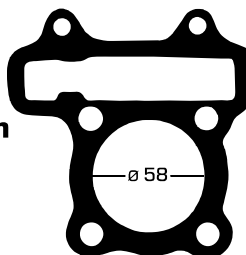

Gilera REVOLUTION P.A.OVAL.

23565 A

MFT ESP. 1,2 mm

23565 M

METAL 3 Láminas

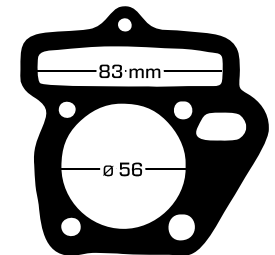

Gilera REVOLUTION P.A.RED.

24438 A

Ø 58 MFT ESP. 1,2 mm

24519 A

Ø 56 MFT ESP. 1,2 mm

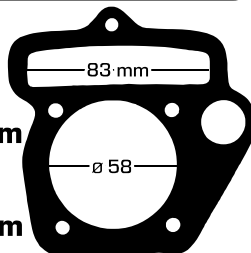

Gilera SMX 400

24487 M

METAL 3 LÁMINAS

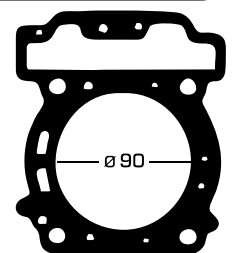

G.M. ANGEL 100.Ho. ELITE 125 M.2000

01355 M

METAL ESP. 0,22 mm

01355 A

MFT ESP. 1,2 mm

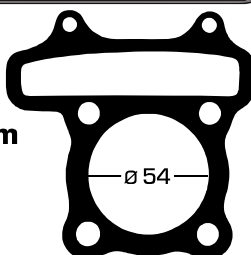

Guerrero TUNDRA 200 (Bal.)

23025 M

METAL ESP. 0,22 mm

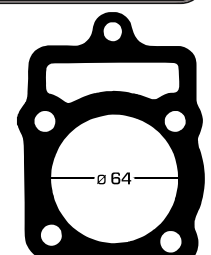

Honda BIZ 125

08927 A

MFT ESP. 1,2 mm

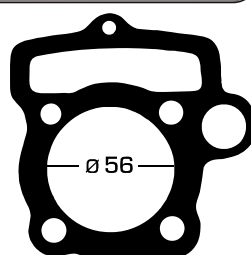

Honda BIZ 125 KS/ES M.2005

23947 M

METAL 3 LÁMINAS

23947 A

MFT ESP. 1,2 mm

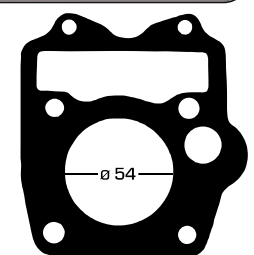



TAPAS CIL. MOTOS

Honda XL/CB 125

01625 A

MFT ESP. 1,2 mm

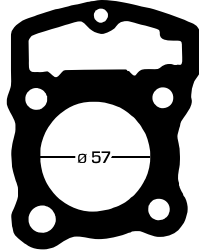

Honda TODAY 125

06691 A

MFT ESP. 1,2 mm

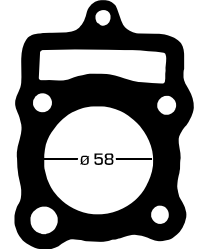

Honda TITAN 125 M.97/2001

06706 M

METAL ESP. 0,22 mm

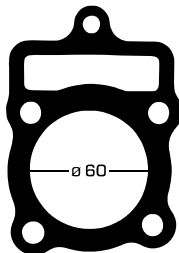

Honda NX 125

01643 A

MFT ESP. 1,2 mm

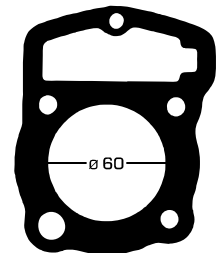

Honda CG 150 TITAN

08153 M

HONDA CG 150 Ø 60

25336 M

HONDA CG 190 Ø 66

25338 M

HONDA CG 220 Ø 71

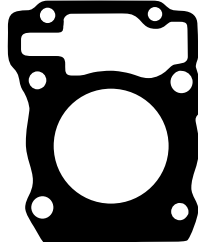

Honda NX 150

01707 A

MFT ESP. 1,2 mm

01707 M

METAL ESP. 0,22 mm

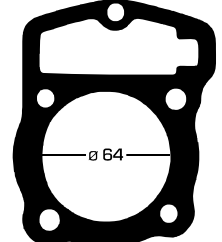

Honda CB 190

25341 M

METAL ESP. 0,22 MM

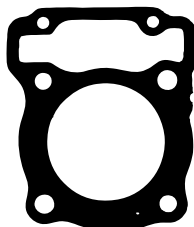

Honda XR 200 Japón

01782 A

MFT ESP. 1,2 mm

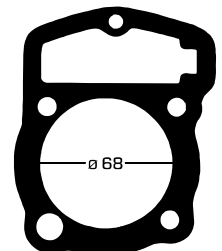

Honda XR 200 Brasil

23413 M

METAL ESP. 0,22 mm

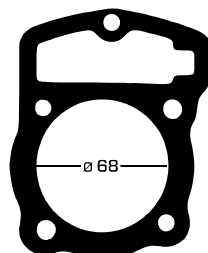

Honda CB 250 NIGHTHAWK

01896 A

MFT ESP. 1,2 mm

01896 M

METAL ESP. 0,22 mm

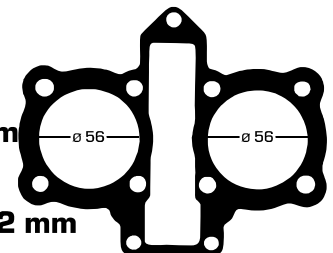

Honda TORNADO/TWISTER 250 (Competición)

Código **Diametro**

25220 - Ø 80
25366 - Ø 81
25367 - Ø 82
25221 - Ø 85
25222 - Ø 86
25223 - Ø 87
25224 - Ø 90
25225 - Ø 92
25226 - Ø 94
25227 - Ø 97

Tapa de Cilindro

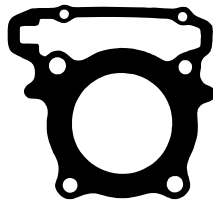

Material MFT

Código + A : Esp. 1,2
Código + B : Esp. 1,5
Código + C : Esp. 2,6
Ej: 25220 B
Tapa Cil. Tornado/Twister
Ø 80 MFT Esp. 1,5 mm
Ej: 25230 B
Base Cil. Tornado/Twister
Ø 88 MFT Esp. 1,5 mm

Base de Cilindro



Código **Diametro**

25465 - Ø 83
25230 - Ø 88
25231 - Ø 99

Honda XR 250 M. 87/99

01886 A

MFT ESP. 1,2 mm

01886 M

METAL 3 Láminas

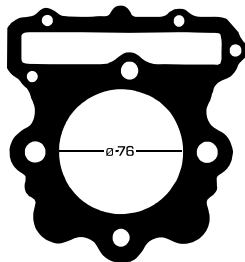

Honda TORNADO/TWISTER 250

23477 A

MFT ESP. 1,2 mm

23477 M

METAL 3 Láminas

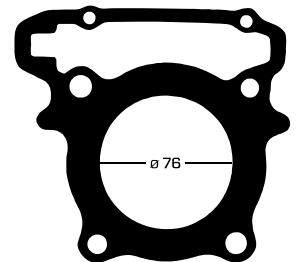

Honda NX 350 SAHARA

01943 M

METAL 3 Láminas

01943 A

MFT ESP. 1,2 mm

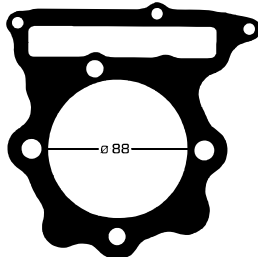

Honda XR 400

02023 A

MFT ESP. 1,2 mm

02023 M

METAL 3 Láminas

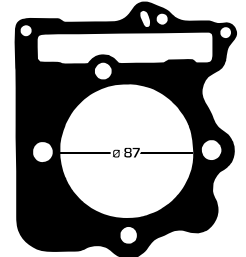

Honda NX 400 FALCON M.99

24476 A

MFT ESP. 1,2 mm

24476 M

METAL 3 Láminas

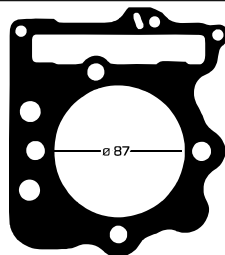

Honda XR 600

02079 A

MFT ESP. 1,2 mm

02079 M

METAL 3 Láminas

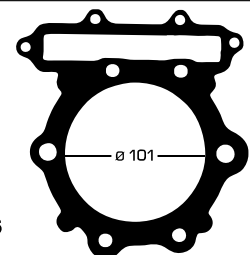

Honda XR/NX 650

02106 A

MFT ESP. 1,2 mm

02106 M

METAL 3 Láminas

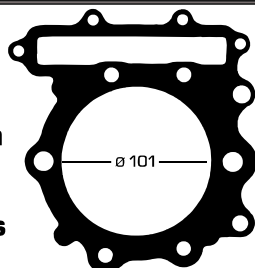

Jawa 300 E

25200 M

METAL ESP. 0,22 mm

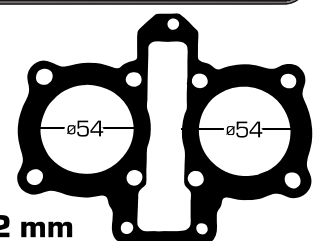



TAPAS CIL. MOTOS

Jawa 350 9

25201 M

METAL ESP. 0,22 mm

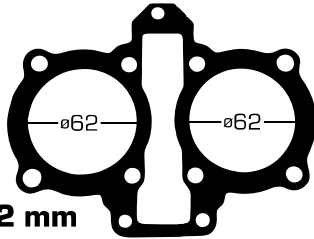

Kawasaki NEO MAX 100

02414 A

MFT ESP. 1,2 mm

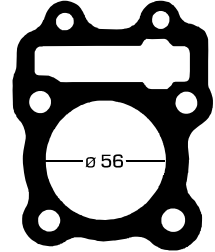

Kawasaki KAZER 100

02447 M

METAL ESP. 0,30 mm

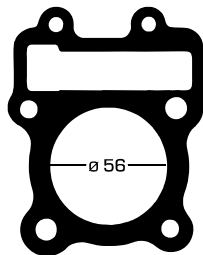

Kawasaki KDX 125

02529 A

MFT C/FONDO COBRE
ESP. 1,2 mm

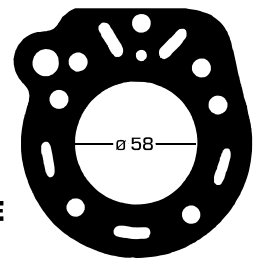

Kawasaki KX 125 M. 94/96

06822 A

MFT ESP. 1,2 mm

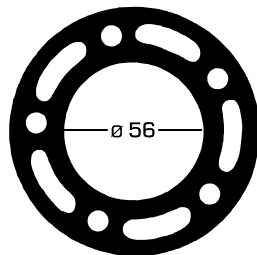

Kawasaki KX/KMX 125

02468 A

MFT ESP. 1,2 mm

02468 M

METAL ESP. 0,22 mm

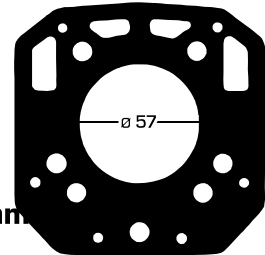

Kawasaki VICTOR 150

02489 A

MFT ESP. 1,2 mm

02489 M

METAL ESP. 0,30 mm

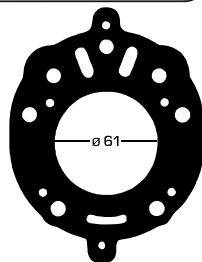

Kawasaki KDX/KX 250

06830 A

MFT C/FONDO COBRE
ESP. 1,2 mm

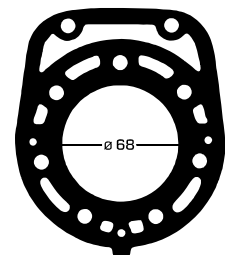

Kawasaki KLR 600/650

06839 A

KLR 600 - Ø 98
MFT ESP. 1,2 mm

02685 A

KLR 650 - Ø 102
MFT ESP. 1,2 mm

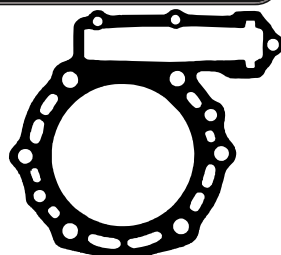

Keller MX 260

24096 M

METAL 3 Láminas

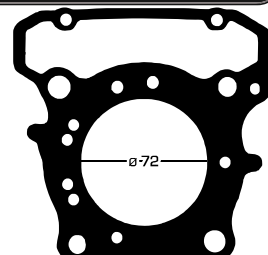

TAPAS CIL. MOTOS



Keller 260 RACING K2/NAKED (Bal.)

24103 A

MFT ESP. 1,2 mm

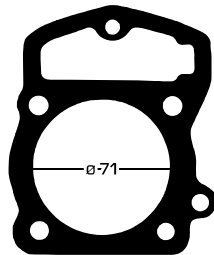

Keller STRATUS 260

24477 M

METAL 4 Láminas
Esp. 1,2 mm

24477 A

MFT Esp. 1,2 mm

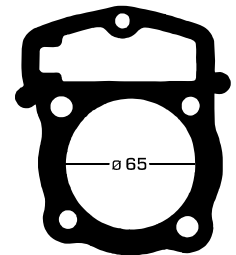

Kymco SPIKE 125

23656 A

MFT ESP. 1,2 mm

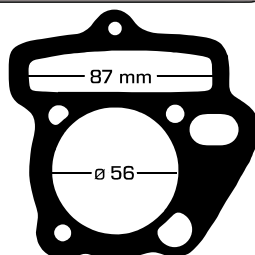

Kymco ACTIVE 125

22761 A

MFT ESP. 1,2 mm

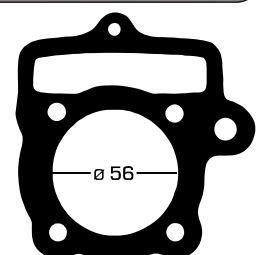

Kymco MXU 150 / Imsa ROAD 150

23956 A

MFT ESP. 1,2 mm

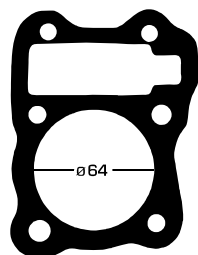

Motomel VX 150

08885 M

METAL ESP. 0,22 mm

08885 A

MFT ESP. 1,2 mm

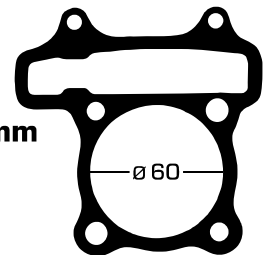

Motomel DAKAR 200 (Var.)

08883 A Ø 66 MFT ESP. 1,2 mm
08883 M Ø 66 METAL ESP. 0,22 mm
24520 A Ø 68 MFT ESP. 1,2 mm
24520 M Ø 68 METAL ESP. 0,22 mm
24467 A Ø 71 MFT ESP. 1,2 mm
24467 M Ø 71 METAL ESP. 0,22 mm

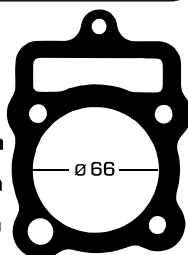

Motomel DAKAR 200 (Cad.)

08928 A Ø 71 MFT ESP. 1,2
08928 M Ø 71 METAL
24523 A Ø 66 MFT ESP. 1,2
24521 A Ø 68 MFT ESP. 1,2

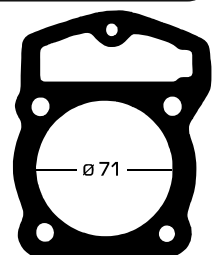

Motomel X3M 125

24236 A

MFT ESP. 1,2 mm

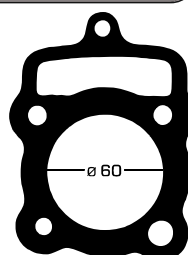

Motomel XPLORA 250

24265 A

Ø 71 MFT ESP. 1,2 mm

24522 A

Ø 68 MFT ESP. 1,2 mm

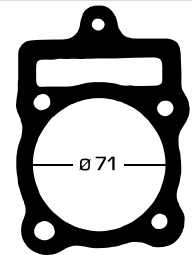



TAPAS CIL. MOTOS

Suzuki AX 100

03083 M

METAL ESP. 0,30 mm

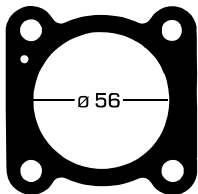

Suzuki 110 FX/FD LOVE

03120 A

MFT ESP. 1,20 mm

03120 M

METAL 3 LÁMINAS

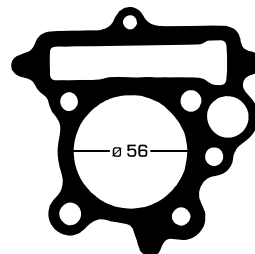

Suzuki DR 125

03134 A

MFT ESP. 1,2 mm

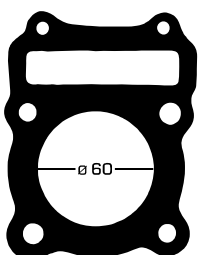

Suzuki EN 125

23771 M

METAL ESP. 0,22 mm

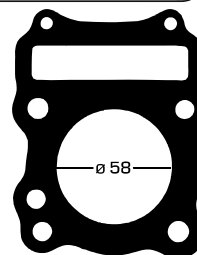

Suzuki DR 200

03264 A

MFT ESP. 1,2 mm

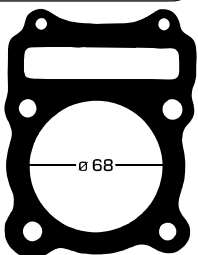

Suzuki DR 350 Hasta M.94

03431 A

MFT ESP 1,2 mm

03431 M

METAL 3 Láminas

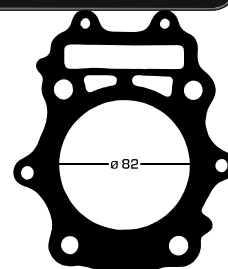

Yamaha CRYPTON 100/105

03851 M

METAL 1 LÁMINA
ESP. 0,3 MM

03851 A

MFT ESP. 1,2 mm

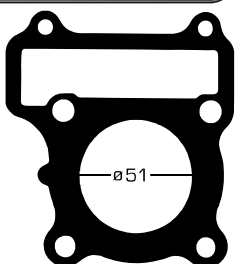

Yamaha NEW CRYPTON 110

24449 M

METAL 1 LÁMINA
ESP. 0,3 MM

24449 A

MFT ESP. 1,2 mm

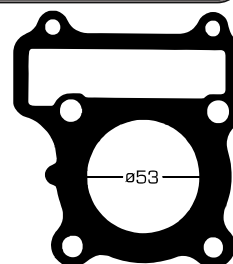

Yamaha YBR/XTZ 125

07118 M

METAL ESP. 0,22 mm

07118 A

MFT ESP. 1,2 mm

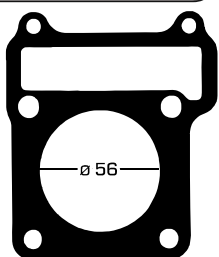

Yamaha FZ 16

23977 M

METAL ESP. 0,22 mm

23977 A

MFT ESP. 1,2 MM

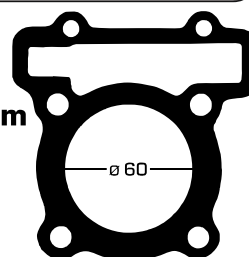

TAPAS CIL. MOTOS



Yamaha XT 225 SEROW

04016 A

MFT ESP. 1,2 mm

04016 M

METAL 3 Láminas

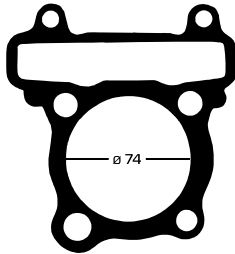

Yamaha YBR/XTZ 250

23790 M

METAL 3 LÁMINAS

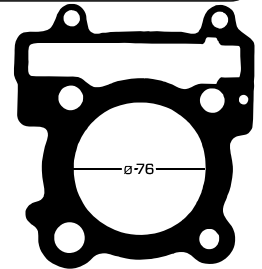

Yamaha XT 250 M.91

04086 A

MFT ESP. 1,2 mm

04086 M

METAL 3 Láminas

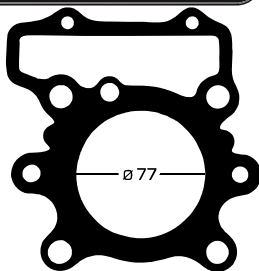

Yamaha XT 350 M.91

04135 A

MFT ESP. 1,2 mm

04135 M

METAL 3 Láminas

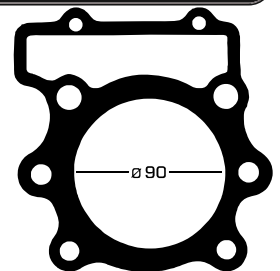

Yamaha XT 600 M.91/99

07163 M

METAL 3 Láminas

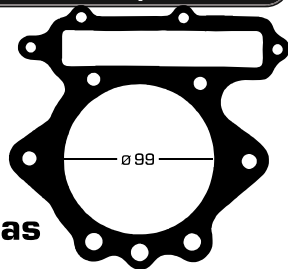

Yamaha TT 600

04188 M

METAL 3 Láminas

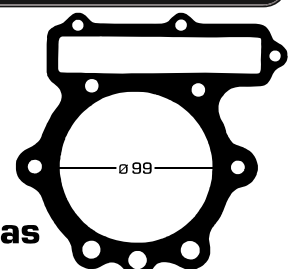

Zanella STYLER 50

24334 M

METAL ESP. 0,22 mm

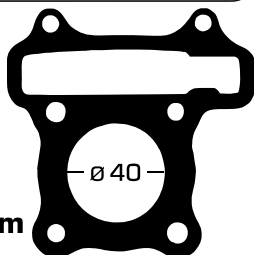

Zanella Vento/ZB 110 3 Valv.

08917 A

MFT ESP. 1,2 mm

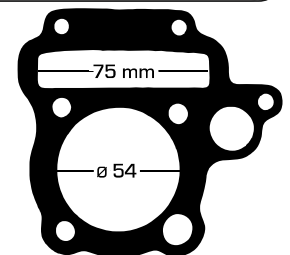

Zanella RX 150 (Var.)

23001 A

MFT ESP. 1,2 mm

23001 M

METAL ESP. 0,22 mm

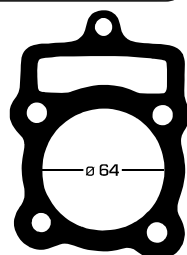

Zanella SCOOTER 150

24343 M

METAL ESP. 0,22 mm

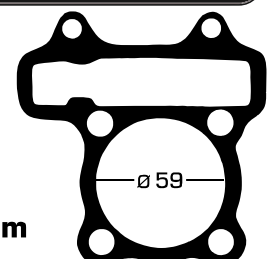



Motos y Cuatriciclos

Bases de Cil. ALMA METAL incluidas en las líneas PREMIUM y PREMIUM C/O'RING



20094 P - APPIA 150 BREZZA (BAL.)

EQUIVALENTES	
APPIA: STRONGER 150 - MONTERO 150 M.N. (VAR. BAL.)	

CODIGO	UNIDAD	MATERIAL
20094 P	JUEGO COMPLETO	PREMIUM C/T. VALV.
20094 P/O	JUEGO COMPLETO	PREM. C/O'RING Y T/V
21095 P	CABEZA DE CILINDRO	PREMIUM
21095 P/O	CABEZA DE CILINDRO	PREM. C/O'RING Y T/V
23738 A/M	BASE DE CILINDRO	ALMA METAL
23739 A	TAPA DE CILINDRO	MFT
23739 M	TAPA DE CILINDRO	METAL
23740	ESCAPE	CHAPA
23741 P	ADMISION (2 X JGO)	PREMIUM
23742 P	EMBRAGUE	PREMIUM
23743 P	CARTER	PREMIUM
23744	BOMBA ACEITE	ADAMITE
23746 P	ENCENDIDO IZQ.	PREMIUM
23748 P	T/CENT. ACEITE	PREMIUM
12-7750	TAPA VALVULAS	NITRILO
9-609	KIT O'RING COMPLETO	NITRILO
8-609	KIT O'RING CABEZA CIL.	NITRILO

20094 P - Juego completo

21095 P - Cabeza de Cilindro

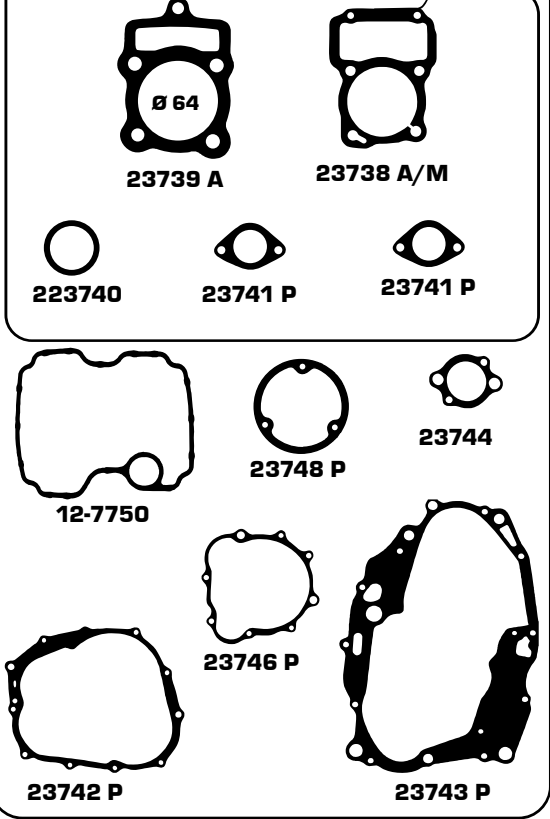

9-609 - Kit O'ring Completo

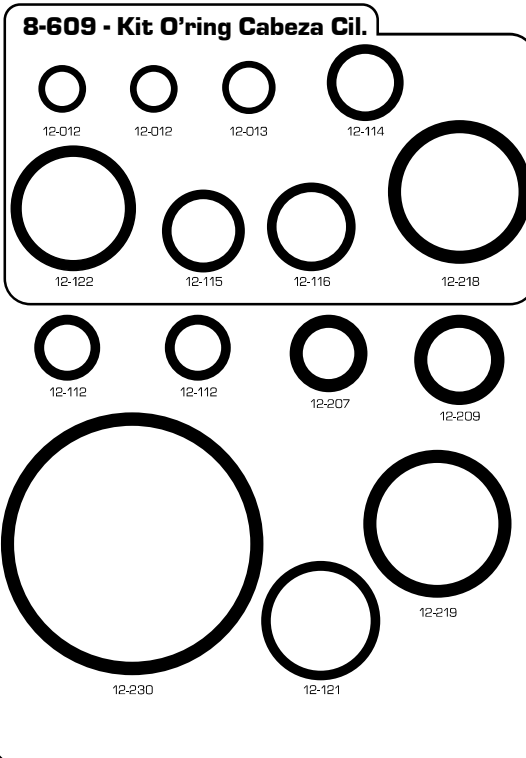

20003 P - APPIA 150 MONTERO (M. VJO.)

Bases de Cil. ALMA METAL
incluidas en las líneas
PREMIUM y PREMIUM C/O RING



EQUIVALENTES	
APPIA:	MONTERO 150 M.08/09 - BLESS 150

CODIGO	UNIDAD	MATERIAL
20003 P	JUEGO COMPLETO	PREMIUM C/T. VALV.
20003 P/O	JUEGO COMPLETO	PREM. C/O RING Y T/V
21041 P	CABEZA DE CILINDRO	PREMIUM
21041 P/O	CABEZA DE CILINDRO	PREM. C/O RING Y T/V
22964 A/M	BASE DE CILINDRO	ALMA METAL
22965 A	TAPA DE CILINDRO	MFT
22965 M	TAPA DE CILINDRO	METAL
22966	ESCAPE	CHAPA
22967 P	ADMISION	PREMIUM
22968 P	EMBRAGUE	PREMIUM
22969 P	CARTER	PREMIUM
22970	BOMBA ACEITE	ADAMITE
22972 P	ENCENDIDO IZQ.	PREMIUM
22974 P	T/CENT. ACEITE	PREMIUM
12-7545	TAPA VALVULAS	NITRILO
9-609	KIT O'RING COMPLETO	NITRILO
8-609	KIT O'RING CABEZA CIL.	NITRILO

20003 P - Juego completo

21041 P - Cabeza de Cilindro



22965 A



22964 A/M



22966



22967 P

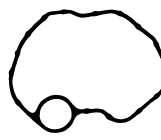

12-7545



22974 P



22970

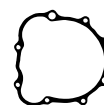

22972 P



22968 P



22969 P

9-609 - Kit O'ring Completo

8-609 - Kit O'ring Cabeza Cil.



12-012



12-012



12-013



12-114

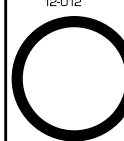

12-122



12-115



12-116

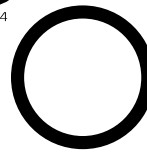

12-218



12-112



12-112



12-207



12-209

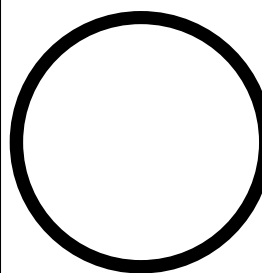

12-230



12-121



12-219

20147 P - BAJAJ 125 XCD (STREET)

Bases de Cil. ALMA METAL
incluidas en las líneas
PREMIUM y PREMIUM C/O RING

EQUIVALENTES

CODIGO	UNIDAD	MATERIAL
20147 P	JUEGO COMPLETO	PREMIUM
21147 P	CABEZA DE CILINDRO	PREMIUM
24001 A/M	BASE DE CILINDRO	ALMA METAL
24002 M	TAPA DE CILINDRO	METAL
24003	ESCAPE	CHAPA
24004 P	ADMISION	PREMIUM
24006 P	EMBRAGUE	PREMIUM
24007 P	CARTER	PREMIUM
24008 P	ENCENDIDO	PREMIUM
24005 P	TENSOR CADENA	PREMIUM
25644 A	ADMISION CHICA	MFT
25621	BOMBA DE ACEITE	ADAMITE

20147 P - Juego completo

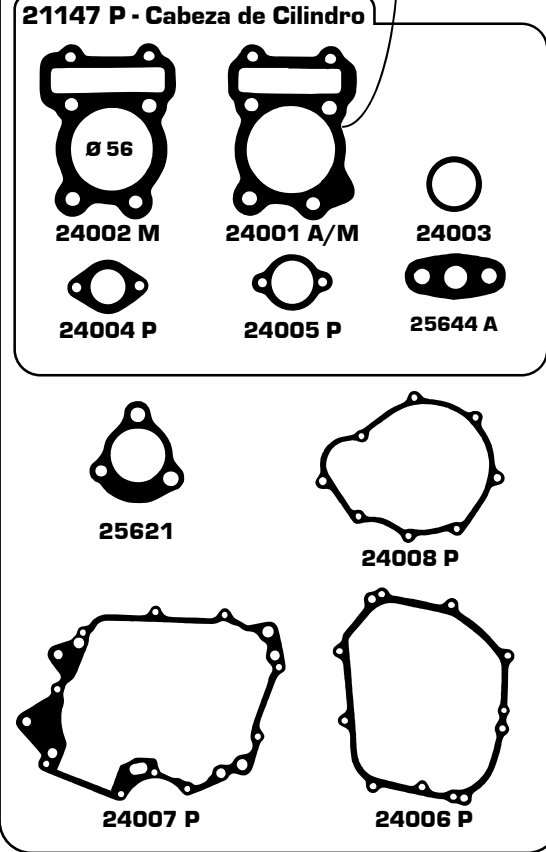

20146 P - BAJAJ 135 ROUSER

Bases de Cil. ALMA METAL
incluidas en las líneas
PREMIUM y PREMIUM C/O RING



EQUIVALENTES

EQUIVALENTES		

CODIGO	UNIDAD	MATERIAL
20146 P	JUEGO COMPLETO	PREMIUM
21146 P	CABEZA DE CILINDRO	PREMIUM
23993 A/M	BASE DE CILINDRO	ALMA METAL
23994 M	TAPA DE CILINDRO	METAL
23995	ESCAPE	CHAPA
23996 P	ADMISION	PREMIUM
23998 P	EMBRAGUE	PREMIUM
23999 P	CARTER	PREMIUM
24505 P	ENCENDIDO	PREMIUM
23997 P	TENSOR CADENA	PREMIUM
25621	BOMBA DE ACEITE	ATE.
25634 A	ADMISION CHICA	MFT
12-7756	TAPA VALVULAS	NITRILO

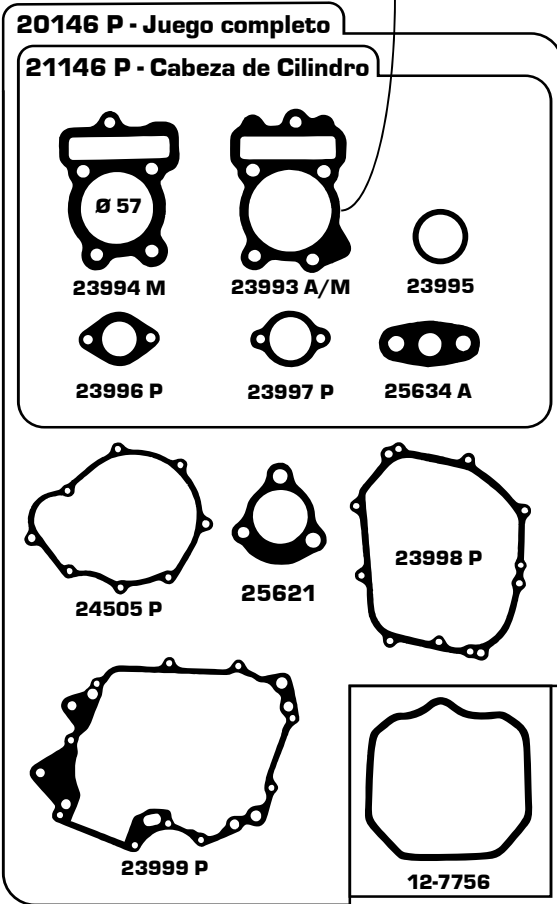

20519 P - BAJAJ 150 BOXER

Bases de Cil. ALMA METAL
incluidas en las líneas
PREMIUM y PREMIUM C/O RING



EQUIVALENTES		

CODIGO	UNIDAD	MATERIAL
20519 P	JUEGO COMPLETO	PREMIUM
21519 P	CABEZA DE CILINDRO	PREMIUM
25630 A/M	BASE DE CILINDRO	ALMA METAL
25631 M	TAPA DE CILINDRO	METAL
25632	ESCAPE	CHAPA
25633 P	ADMISION	PREMIUM
25635 P	EMBRAGUE	PREMIUM
25636 P	CARTER	PREMIUM
25637 P	ENCENDIDO	PREMIUM
25638 P	TENSOR CADENA	PREMIUM
25621	BOMBA DE ACEITE	ADAMITE
25634 A	ADMISION CHICA	MFT
12-7756	TAPA VALVULAS	NITRILO

20519 P - Juego completo

21519 P - Cabeza de Cilindro

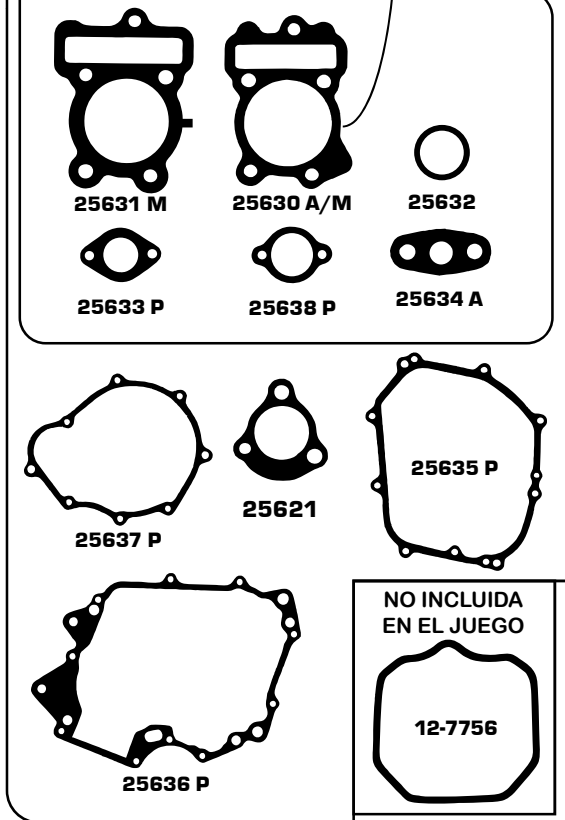

25631 M 25630 A/M 25632
 25633 P 25638 P 25634 A

25637 P 25621 25635 P

25636 P

NO INCLUIDA EN EL JUEGO
 12-7756



Motos y Cuatriciclos

20450 P - BAJAJ NS 150

Bases de Cil. ALMA METAL
incluidas en las líneas
PREMIUM y PREMIUM C/O RING



EQUIVALENTES

EQUIVALENTES		

CODIGO	UNIDAD	MATERIAL
20450 P	JUEGO COMPLETO	PREMIUM
21450 P	CABEZA DE CILINDRO	PREMIUM
25300 A/M	BASE DE CILINDRO	ALMA METAL
25301 M	TAPA DE CILINDRO	METAL
25302	ESCAPE	CHAPA
25303 P	ADMISION	PREMIUM
25304 P	EMBRAGUE	PREMIUM
25305 P	ENCENDIDO	PREMIUM
25306 P	TENSOR CADENA	PREMIUM

20450 P - Juego Completo

21092 P - Cabeza de Cilindro

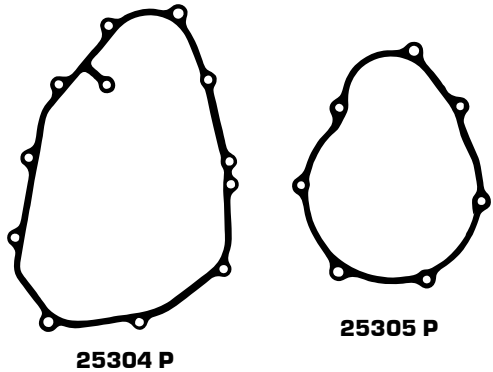
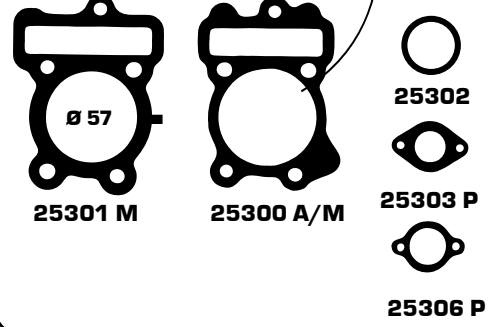



20191 P - BAJAJ 180 ROUSER

Bases de Cil. ALMA METAL
incluidas en las líneas
PREMIUM y PREMIUM C/O RING



EQUIVALENTES		

CODIGO	UNIDAD	MATERIAL
20191 P	JUEGO COMPLETO	PREMIUM
21191 P	CABEZA DE CILINDRO	PREMIUM
24016 A/M	BASE DE CILINDRO	ALMA METAL
24424 M	TAPA DE CILINDRO	METAL
24018	ESCAPE	CHAPA
24019 P	EMBRAGUE	PREMIUM
23967 P	CARTER A	PREMIUM
24020 P	CARTER B	PREMIUM
24021 P	ENCENDIDO	PREMIUM
24022 P	TENSOR CADENA	PREMIUM

20191 P - Juego completo

21191 P - Cabeza de Cilindro



24424 M



24016 A/M



24018



24022 P



24021 P

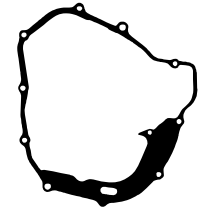

24019 P

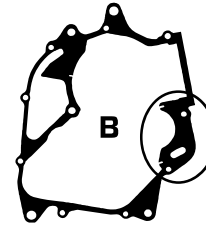

24020 P

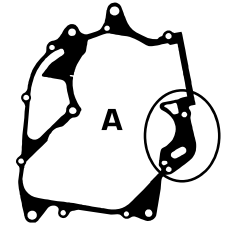

23967 P

Bases de Cil. ALMA METAL
incluidas en las líneas
PREMIUM y PREMIUM C/O RING



20506 P - BENELLI 150 TNT -15

EQUIVALENTES	

CODIGO	UNIDAD	MATERIAL
20506 P	JUEGO COMPLETO	PREMIUM
20506 P/O	JUEGO COMPLETO	PREMIUM C/O'RING
21506 P	CABEZA DE CILINDRO	PREMIUM
25547 A/M	BASE DE CILINDRO	ALMA METAL
25548 M	TAPA DE CILINDRO	METAL
25549	ESCAPE	CHAPA
25550 P	EMBRAGUE	PREMIUM
25551 P	ALTERNADOR	PREMIUM
25552 P	TENSOR DIST.	PREMIUM
9-633	KIT O'RING JUEGO COMP.	NITRILO

20097 P - Juego completo

21099 P - Cabeza de Cilindro



25548 M

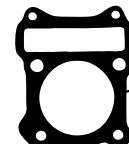

25547 A/M



25549



25552 P

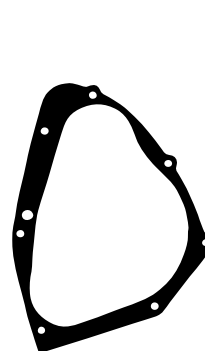

25551 P

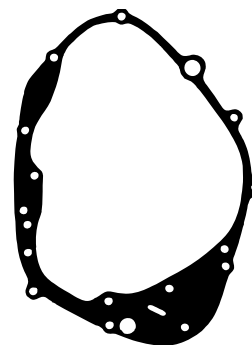

25552 P

9-633 - Kit O´ring Completo



12-015

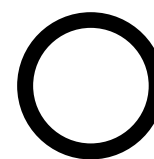

12-217

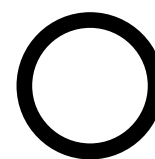

12-217

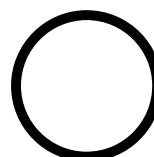

12-125

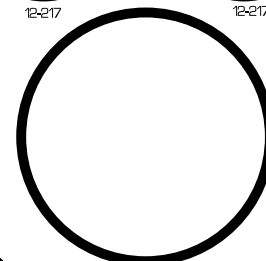

12-142

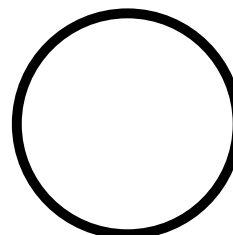

12-138



12-011

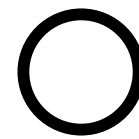

12-21

20451 P - BETA AKVO 150

Bases de Cil. ALMA METAL
incluidas en las líneas
PREMIUM y PREMIUM C/O RING



EQUIVALENTES

CODIGO	UNIDAD	MATERIAL
20451 P	JUEGO COMPLETO	PREMIUM
21451 P	CABEZA DE CILINDRO	PREMIUM
25307 A/M	BASE DE CILINDRO	ALMA METAL
25307 P	BASE DE CILINDRO	PREMIUM
25308 M	TAPA DE CILINDRO	METAL
25308 A	TAPA DE CILINDRO	MFT
25309	ESCAPE	CHAPA
25310 P	EMBRAGUE	PREMIUM
25311 P	CARTER	PREMIUM
25312 P	ENCENDIDO	PREMIUM
25313 P	TENSOR CADENA	PREMIUM
25314 P	BOMBA AGUA	PREMIUM
25315 A	REC. DE GASES	MFT

20451 P - Juego Completo

21451 P - Cabeza de Cilindro



25308 M

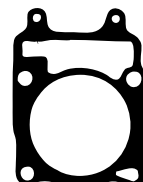

25307 A/M



25309



25313 P



25315 A

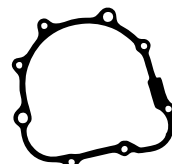

25312 P



25314 P

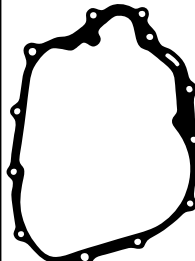

25310 P

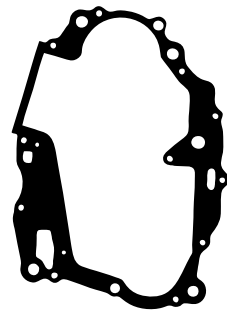

25311 P

20149 P - BETA 200 MOTARD

Bases de Cil. ALMA METAL
incluidas en las líneas
PREMIUM y PREMIUM C/O'RING



EQUIVALENTES

BETA: TR 2.0 - CHRONO 200

CODIGO	UNIDAD	MATERIAL
20149 P	JUEGO COMPLETO	PREMIUM.
20149 P/O	JUEGO COMPLETO	PREMIUM C/O'RING
21149 P	CABEZA DE CILINDRO	PREMIUM
21149 P/O	CABEZA DE CILINDRO	PREMIUM C/O'RING
24429 A/M	BASE DE CILINDRO	ALMA METAL
24430 A	TAPA DE CILINDRO	MFT
24430 M	TAPA DE CILINDRO	METAL
24431	ESCAPE	CHAPA
24432 P	EMBRAGUE	PREMIUM
24433 P	ALTERNADOR	PREMIUM
24434 P	TENSOR CADENA	PREMIUM
9-647	KIT O'RING COMPLETO	NITRILO
8-647	KIT O'RING CABEZA CIL.	NITRILO

20149 P - Juego completo

21149 P - Cabeza de Cilindro



24430 A

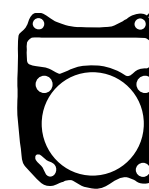

24429 A/M



24431



24434 P

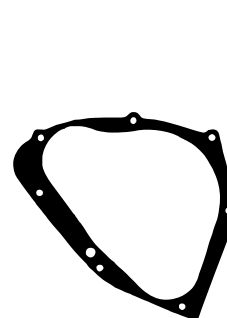

24433 P

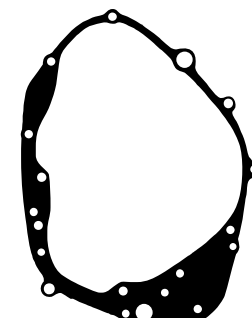

24432 P

9-647 - Kit O'ring Completo

8-647 - Kit O'ring Cabeza Cil.

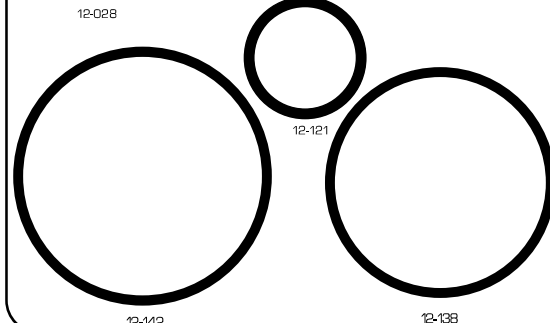
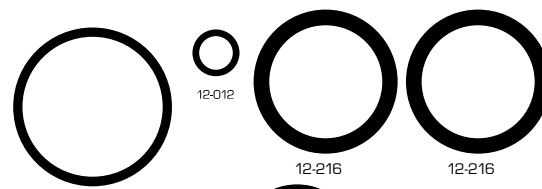
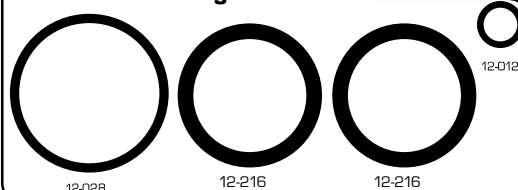

20330 P - BETA 300 EURO

Bases de Cil. ALMA METAL
incluidas en las líneas
PREMIUM y PREMIUM C/O RING



EQUIVALENTES	

CODIGO	UNIDAD	MATERIAL
20330 P	JUEGO COMPLETO	PREMIUM
21330 P	CABEZA DE CILINDRO	PREMIUM
25010 A/M	BASE DE CILINDRO	ALMA METAL
25011 M	TAPA DE CILINDRO	METAL
25011 C	TAPA DE CILINDRO	MFT C/FDO COBRE 1MM
25012	ESCAPE	CHAPA
25225 P	EMBRAGUE	PREMIUM
25226 P	ALTERNADOR	PREMIUM

20330 P - Juego Completo

21330 P - Cabeza de Cilindro

25011 M 25010 A/M 25012

25225 P 25226 P

06114 P - GILERA SMASH 110 (Ø 54 - CAD. 75 MM - P.A.RED.)

EQUIVALENTES
APPIA: ANDINA - CITI PLUS / BETA: BS - URBA
BRAVA: ALPINA - APOLO - NEVADA / CORVEN: ENERGY - MIRAGE
DA-DALT: DS / GILERA: C DLX - ESTILO - FUTURA - GLA
GUERRERO: BIKE-FLASH-FUTURE-G DL-GN KEOKEN-GW WARRIOR-TRIP
HONDA: BIZ 105 / IMSA: TRACK EVO / CERRO: BIX - FLY - LINK
KELLER: BIG - CRONO CLASSIC - TITAN / KYMCO: ACTIV
KONISA: MAGNIFICA - TUCUBIZ / MAVERICK: H / MONIDAL: LD
MOTOMEL: BIT - C DLX - CLIPPER - FD
ZANELLA: DUE - SEXY - SWING - VENTO 2V. - ZB 2V.

CODIGO	UNIDAD	MATERIAL
06114 P	JUEGO COMPLETO	PREMIUM
06114 P/O	JUEGO COMPLETO	PREMIUM C/O'RING
06369 P	CABEZA DE CILINDRO	PREMIUM
06369 P/O	CABEZA DE CILINDRO	PREMIUM C/O'RING
07846 A/M	BASE DE CILINDRO	ALMA METAL
07847 A	TAPA DE CILINDRO	MFT
07847 M	TAPA DE CILINDRO	METAL
07848	ESCAPE	CHAPA
07849 P	ADMISION AL CIL.	PREMIUM
07849 S	ADMISION AL CARB.	PREMIUM
07850 P	EMBRAGUE	PREMIUM
07851 P	CARTER	PREMIUM
07852	BOMBA ACEITE	ADAMITE
07853 P	ENCENDIDO	PREMIUM
07854 P	T/CABEZA DE CIL.	PREMIUM
07855 P	LAT. IZQ. CHICO	PREMIUM
06658 P	LAT. IZQ. GRANDE	PREMIUM
07856 P	LATERAL DERECHO	PREMIUM
07857	FILTRO ACEITE	ADAMITE
01538	FILTRO ACEITE	ADAMITE
07858 P	CENTRIFUGO	PREMIUM
01509 P	CENTRIFUGO	PREMIUM
9-605	KIT O'RING COMPLETO	NITRILO
8-605	KIT O'RING CABEZA CIL.	NITRILO
9-638	KIT O'RING TAPA CIL.	NITRILO

06114 P - Juego completo

Bases de Cil. ALMA METAL incluidas en las líneas PREMIUM y PREMIUM C/O'RING

06369 P - Cabeza de Cilindro

07847 M 07846 A/M 07849 P

06658 P 07855 P 07849 S

07848 07856 P 07854 P

01538 07857 07852 07858 P 01509 P

07853 P 07850 P 07851 P

9-605 - Kit O'ring Completo

8-605 - Kit O'ring Cabeza Cil.

9-638 - Kit O'ring Tapa de Cil.

12-7485 12-7486 12-7487 11-0303

12-217 12-217 12-120

12-113 12-209

12-010 12-010

12-046 12-023

20016 P - GILERA SMASH 110 (Ø 54 - CAD. 83 MM - P.A.RED.)

EQUIVALENTES

GUERRERO: FLASH 110 - TRIP 110

CODIGO	UNIDAD	MATERIAL
20016 P	JUEGO COMPLETO	PREMIUM
20016 P/O	JUEGO COMPLETO	PREMIUM C/O'RING
21014 P	CABEZA DE CILINDRO	PREMIUM
21014 P/O	CABEZA DE CILINDRO	PREMIUM C/O'RING
22286 A/M	BASE DE CILINDRO	ALMA METAL
22287 A	TAPA DE CILINDRO	MFT
22287 M	TAPA DE CILINDRO	METAL
22288	ESCAPE	CHAPA
22289 P	ADMISION AL CIL.	PREMIUM
22299 P	ADMISION AL CARB.	PREMIUM
22290 P	EMBRAGUE	PREMIUM
22291 P	CARTER	PREMIUM
22292	BOMBA ACEITE	ADAMITE
22293 P	ENCENDIDO	PREMIUM
22294 P	T/CABEZA DE CIL.	PREMIUM
22295 P	T/DISTRIBUCION	PREMIUM
22296 P	LATERAL DERECHO	PREMIUM
22297	FILTRO ACEITE	ADAMITE
07583	FILTRO ACEITE SMASH	ADAMITE
22298 P	CENTRIFUGO	PREMIUM
01509 P	CENTRIFUGO	PREMIUM
9-605	KIT O'RING COMPLETO	NITRILO
8-605	KIT O'RING CABEZA CIL.	NITRILO
9-638	KIT O'RING TAPA CIL.	NITRILO

20016 P - Juego completo

21014 P - Cabeza de Cilindro

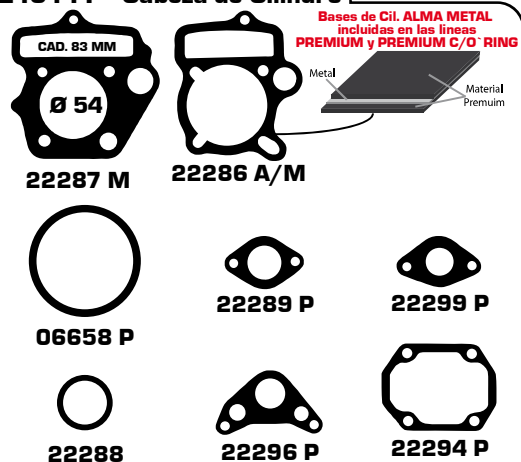

9-605 - Kit O´ring Completo

8-605 - Kit O´ring Cabeza Cil.

9-638 - Kit O´ring Tapa de Cil.

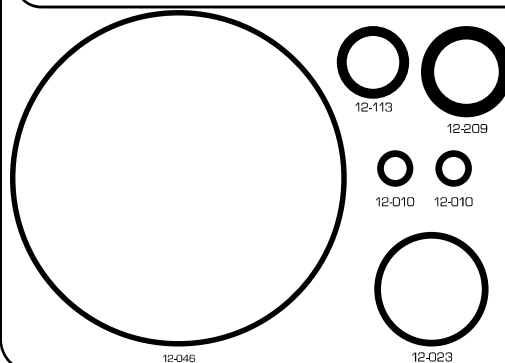
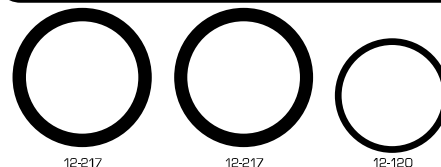

20076 P - GILERA SMASH 125 REVOLUTION (P.A.RED.)

EQUIVALENTES
APPIA: BERAKA 125 - GEREMY 125 / BRAVA: ATHENE 125
KELLER: CRONO TRIAL 125 / KONISA: CITIZEN 125 - KONITOP 125-KONISTAR
MAVERICK: SUPRA 125 / MONDIAL: LD 125
MOTOMEL: TOP 125 (CUBS) - BLITZ 125 - SKORPIO 125 / OKINOI: 125
ZANELLA: SEXY 125 - DUE 125

CODIGO	UNIDAD	MATERIAL
20076 P	JUEGO COMPLETO	PREMIUM
20076 P/O	JUEGO COMPLETO	PREMIUM C/O'RING
21078 P	CABEZA DE CILINDRO	PREMIUM
21078 P/O	CABEZA DE CILINDRO	PREMIUM C/O'RING
23564 A/M	BASE DE CILINDRO	ALMA METAL
23565 A	TAPA DE CILINDRO	MFT
23565 M	TAPA DE CILINDRO	METAL
23566	ESCAPE	CHAPA
23567 P	ADMISION AL CIL.	PREMIUM
23568 p	ADMISION AL CARB.	PREMIUM
23569 P	EMBRAGUE	PREMIUM
23570 P	CARTER	PREMIUM
23571	BOMBA ACEITE	ADAMITE
23572 P	ENCENDIDO	PREMIUM
23573 P	T/CABEZA DE CIL.	PREMIUM
23574 P	T/DISTRIBUCION	PREMIUM
23575 P	LATERAL DERECHO	PREMIUM
23576	FILTRO ACEITE	ADAMITE
07852	FILTRO ACEITE	ADAMITE
23577 P	CENTRIFUGO	PREMIUM
01509 P	CENTRIFUGO	PREMIUM
9-605	KIT O'RING COMPLETO	NITRILO
8-605	KIT O'RING CABEZA CIL.	NITRILO
9-638	KIT O'RING TAPA CIL.	NITRILO

20076 P - Juego completo

Bases de Cil. ALMA METAL incluidas en las líneas PREMIUM y PREMIUM C/O' RING

21078 P - Cabeza de Cilindro

23565 M 23564 A/M
 06658 P 23567 P 23568 S
 23566 23575 P 23574 P
 23576 07852 23571 23577 P 01509 P
 23572 P 23569 P 23570 P

9-605 - Kit O'ring Completo

8-605 - Kit O'ring Cabeza Cil.

9-638 - Kit O'ring Tapa de Cil.

12-7485 12-7486 12-7487 11-0303
 12-217 12-217 12-120
 12-113 12-209
 12-010 12-010
 12-046 12-023

20021 P - GILERA SMX 200 (VAR. BAL. CORTO)

EQUIVALENTES

GILERA: SAHEL 200 (VAR. BAL. CORTO) - VC 200 (VAR. BAL. CORTO)
GUERRERO: TUNDRA GXR 200 (VAR. BAL. CORTO)
MOTOMEL: SKUA 200 MOTARD(VAR. BAL. CORTO)

CODIGO	UNIDAD	MATERIAL
20021 P	JUEGO COMPLETO	PREMIUM C/T. VALV.
20021 P/O	JUEGO COMPLETO	PREM. C/O'RING Y T/V
21055 P	CABEZA DE CILINDRO	PREMIUM
21055 P/O	CABEZA DE CILINDRO	PREM. C/O'RING Y T/V
23197 A/M	BASE DE CILINDRO	ALMA METAL
23198 M	TAPA DE CILINDRO	METAL
23199	ESCAPE	CHAPA
23200 P	ADMISION (2 X JGO)	PREMIUM
23201 P	EMBRAGUE	PREMIUM
23202 P	CARTER	PREMIUM
23203	BOMBA ACEITE	ADAMITE
23205 P	ENCENDIDO IZQ.	PREMIUM
23207 P	T/CENT. ACEITE	PREMIUM
12-7545	TAPA VALVULAS	NITRILO
9-642	KIT O'RING COMPLETO	NITRILO
8-642	KIT O'RING CABEZA CIL.	NITRILO

Bases de Cil. ALMA METAL
 incluidas en las lineas
PREMIUM y PREMIUM C/O'RING



20021 P - Juego completo

21055 P - Cabeza de Cilindro

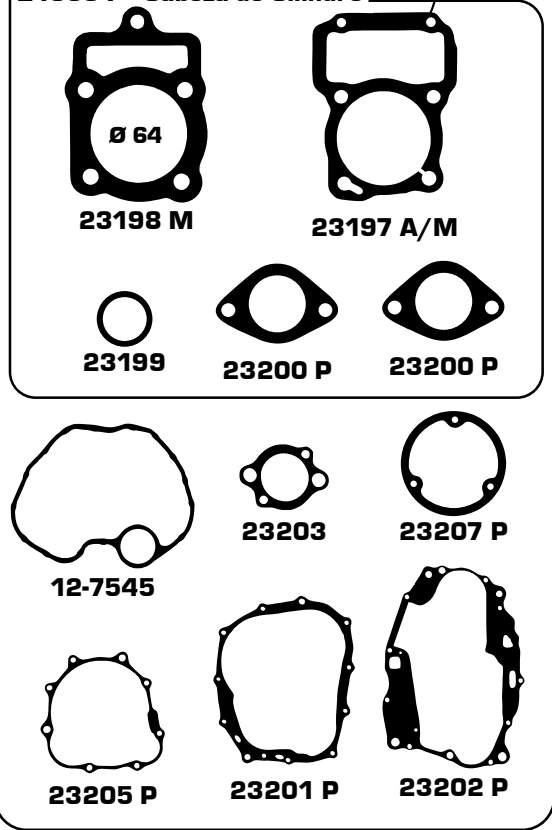

9-642 - Kit O'ring Completo

8-642 - Kit O'ring Cabeza Cil.

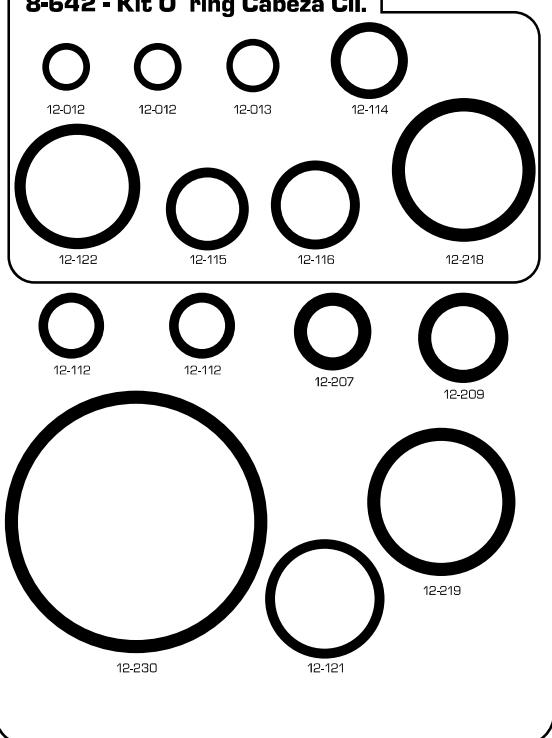

20258 P - GILERA VCR 200

Bases de Cil. ALMA METAL
incluidas en las líneas
PREMIUM y PREMIUM C/O'RING



EQUIVALENTES

MOTOMEL: SKUA 200 (CAD. BAL.) - SR 200 (CAD. BAL.)

TCP 200 (CAD. BAL.)

CODIGO	UNIDAD	MATERIAL
20258 P	JUEGO COMPLETO	PREMIUM
20258 P/O	JUEGO COMPLETO	PREMIUM C/O'RING
21258 P	CABEZA DE CILINDRO	PREMIUM
21258 P/O	CABEZA DE CILINDRO	PREMIUM C/O'RING
25273 A/M	BASE DE CILINDRO	ALMA METAL
25274 A	TAPA DE CILINDRO	MFT
25274 M	TAPA DE CILINDRO	METAL
25275	ESCAPE	CHAPA
25276 P	ADMISION (2 X JGO)	PREMIUM
25277 P	EMBRAGUE	PREMIUM
25278 P	CARTER	PREMIUM
25279	BOMBA ACEITE	ADAMITE
25280 P	ENCENDIDO IZQ.	PREMIUM
25283 P	T/CENT. ACEITE	PREMIUM
25282 P	ABOL DE LEVAS	PREMIUM
25281 P	TENSOR CADENA	PREMIUM
9-643	KIT O'RING COMPLETO	NITRILO
8-643	KIT O'RING CABEZA CIL.	NITRILO

20258 P - Juego completo

21258 P - Cabeza de Cilindro



25274 A



25273 A/M



25276 P



25276 P



25277



25281 P

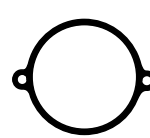

25282 P



25283 P



25279

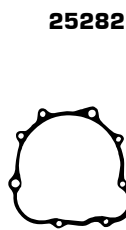

25280 P



25277 P



25278 P

9-643 - Kit O'ring Completo

8-643 - Kit O'ring Cabeza Cil.

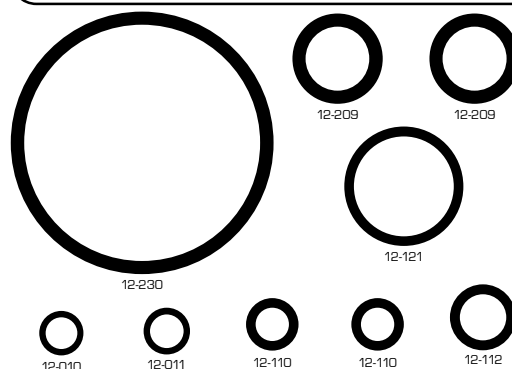
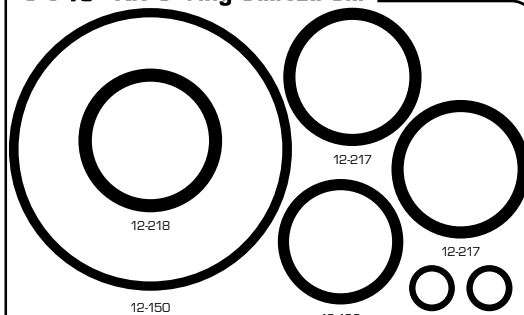

20287 P - GILERA SMX 400

Bases de Cil. ALMA METAL
incluidas en las líneas
PREMIUM y PREMIUM C/O RING



EQUIVALENTES

CODIGO	UNIDAD	MATERIAL
20287 P	JUEGO COMPLETO	PREMIUM
21287 P	CABEZA DE CILINDRO	PREMIUM
24486 A/M	BASE DE CILINDRO	ALMA METAL
24487 M	TAPA DE CILINDRO	METAL
24488	ESCAPE	CHAPA
24489 P	EMBRAGUE	PREMIUM
24490 P	CARTER	PREMIUM
24494 P	ALTERNADOR	PREMIUM
24495 A/M	JUNTA CHICA	ALMA METAL

20287 P - Juego completo

21287 P - Cabeza de Cilindro

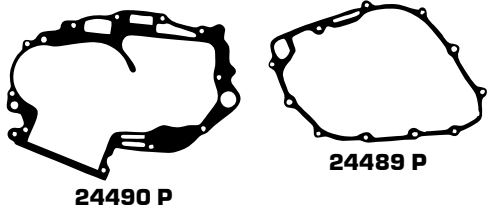
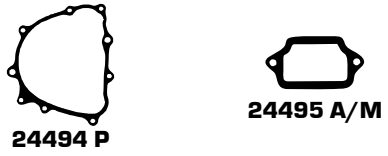
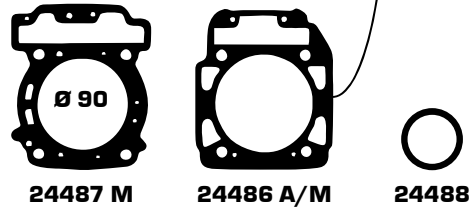

00354 P - GUERRERO G 70 (A/ELECT.)

EQUIVALENTES
GUERRERO: FUTURE 70
MOTOMEL: ECO A/E
ZANELLA: TRICARGO 70

CODIGO	UNIDAD	MATERIAL
00354 P	JUEGO COMPLETO	PREMIUM
00354 P/O	JUEGO COMPLETO	PREMIUM C/O'RING
00639 P	CABEZA DE CILINDRO	PREMIUM
00639 P/O	CABEZA DE CILINDRO	PREMIUM C/O'RING
22671 A/M	BASE DE CILINDRO	ALMA METAL
22672 A	TAPA DE CILINDRO	MFT
22672 M	TAPA DE CILINDRO	METAL
22673	ESCAPE	CHAPA
22674 P	ADMISION AL CIL.	PREMIUM
22683 P	ADMISION AL CARB.	PREMIUM
22675 P	EMBRAGUE	PREMIUM
22676 P	CARTER	PREMIUM
22677	BOMBA ACEITE	ADAMITE
02439 P	ENCENDIDO	PREMIUM
22678 P	T/CABEZA DE CIL.	PREMIUM
22679 P	T/DISTRIBUCION	PREMIUM
22680 P	LATERAL DERECHO	PREMIUM
22681	FILTRO ACEITE	ADAMITE
22682 P	CENTRIFUGO ACEITE	PREMIUM
9-605	KIT O´RING COMPLETO	NITRILO
8-605	KIT O´RING CABEZA CIL.	NITRILO
9-638	KIT O´RING TAPA CIL.	NITRILO

00354 P - Juego completo

00639 P - Cabeza de Cilindro

Bases de Cil. ALMA METAL
incluidas en las líneas
PREMIUM y PREMIUM C/O´RING

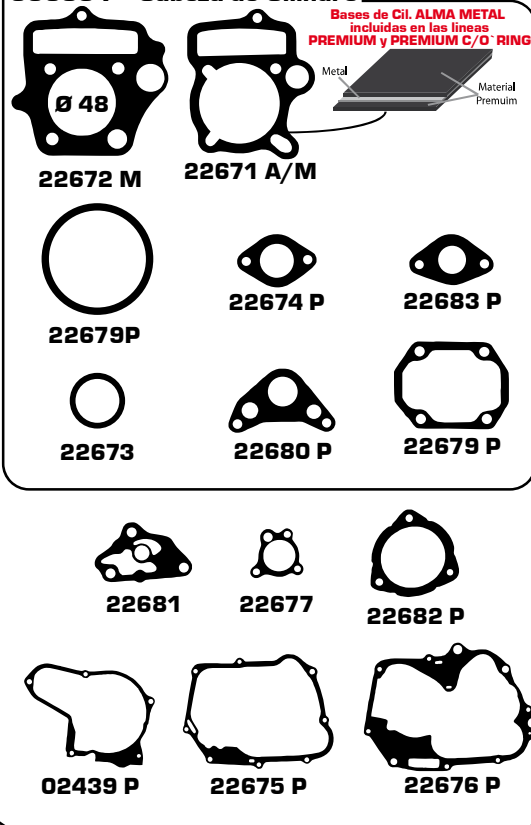

9-605 - Kit O´ring Completo

8-605 - Kit O´ring Cabeza Cil.

9-638 - Kit O´ring Tapa de Cil.

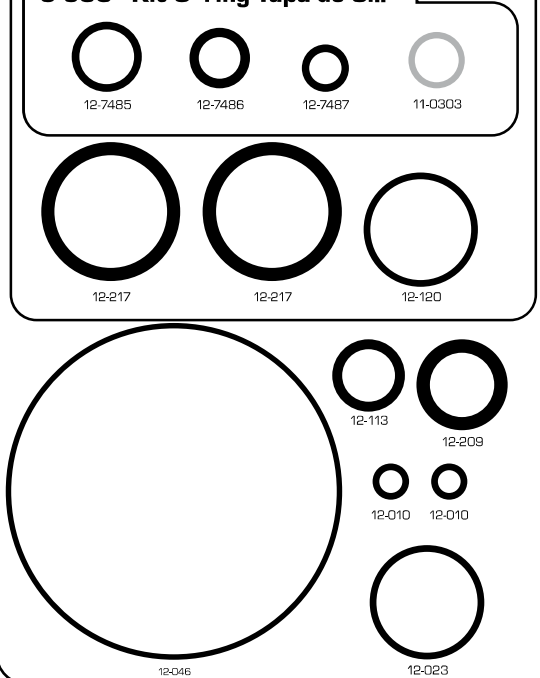

06021 P - G. TRIP 110 (Ø 54 - CAD. 83 MM - P.A.OVAL.)

EQUIVALENTES
APPIA: DCN 110 - VECTRA 110
GILERA: SMASH 110 - FX 125 P.A.OVAL.
GUERRERO: FLASH 110

CODIGO	UNIDAD	MATERIAL
06021 P	JUEGO COMPLETO	PREMIUM
06021 P/O	JUEGO COMPLETO	PREMIUM C/O'RING
06279 P	CABEZA DE CILINDRO	PREMIUM
06279 P/O	CABEZA DE CILINDRO	PREMIUM C/O'RING
06649 A/M	BASE DE CILINDRO	ALMA METAL
06650 A	TAPA DE CILINDRO	MFT
06650 M	TAPA DE CILINDRO	METAL
06651	ESCAPE	CHAPA
06652 P	ADMISION AL CIL.	PREMIUM
06652 S	ADMISION AL CARB.	PREMIUM
06653 P	EMBRAGUE	PREMIUM
06654 P	CARTER	PREMIUM
06655	BOMBA ACEITE	ADAMITE
06656 P	ENCENDIDO	PREMIUM
06657 P	T/CABEZA DE CIL.	PREMIUM
06658 P	T/DISTRIBUCION	PREMIUM
06659 P	LATERAL DERECHO	PREMIUM
06660	FILTRO ACEITE	ADAMITE
06661 P	CENTRIFUGO ACEITE	PREMIUM
9-605	KIT O'RING COMPLETO	NITRILO
8-605	KIT O'RING CABEZA CIL.	NITRILO
9-638	KIT O'RING TAPA CIL.	NITRILO

06021 P - Juego completo

06279 P - Cabeza de Cilindro

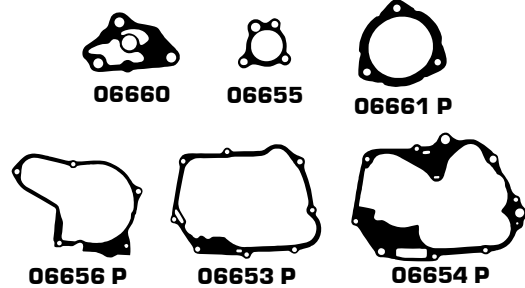
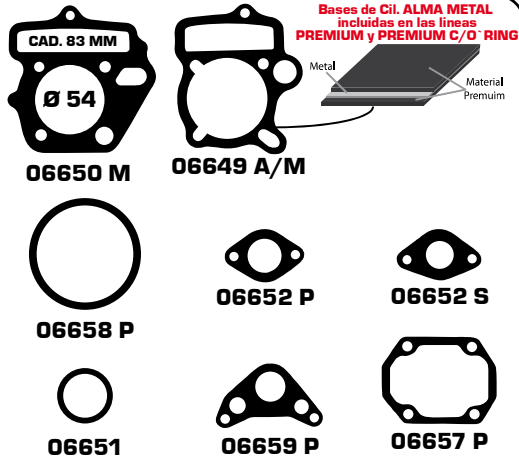

9-605 - Kit O'ring Completo

8-605 - Kit O'ring Cabeza Cil.

9-638 - Kit O'ring Tapa de Cil.

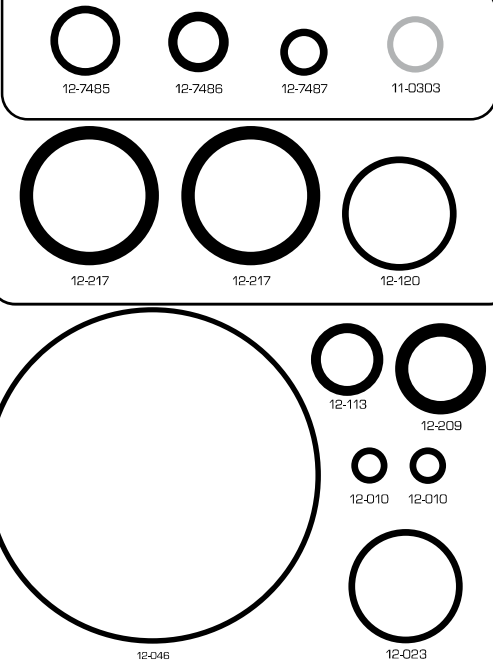

20504 P - GUERRERO GLS 150 ANDIAMO

Bases de Cil. ALMA METAL
incluidas en las líneas
PREMIUM y PREMIUM C/O´RING

EQUIVALENTES

CODIGO	UNIDAD	MATERIAL
20504 P	JUEGO COMPLETO	PREMIUM
20504 P/O	JUEGO COMPLETO	PREMIUM C/O´RING
21504 P	CABEZA DE CILINDRO	PREMIUM
21504 P/O	CABEZA DE CILINDRO	PREMIUM C/O´RING
25528 A/M	BASE DE CILINDRO	ALMA METAL
25528 P	BASE DE CILINDRO	PREMIUM
25529 A	TAPA DE CILINDRO	MFT
25529 M	TAPA DE CILINDRO	METAL
25530	ESCAPE	CHAPA
25531 P	ADMISION	PREMIUM
25532 P	CARTER	PREMIUM
25534 P	TENSOR CADENA	PREMIUM
25535 P	TRANS. CADENA	PREMIUM

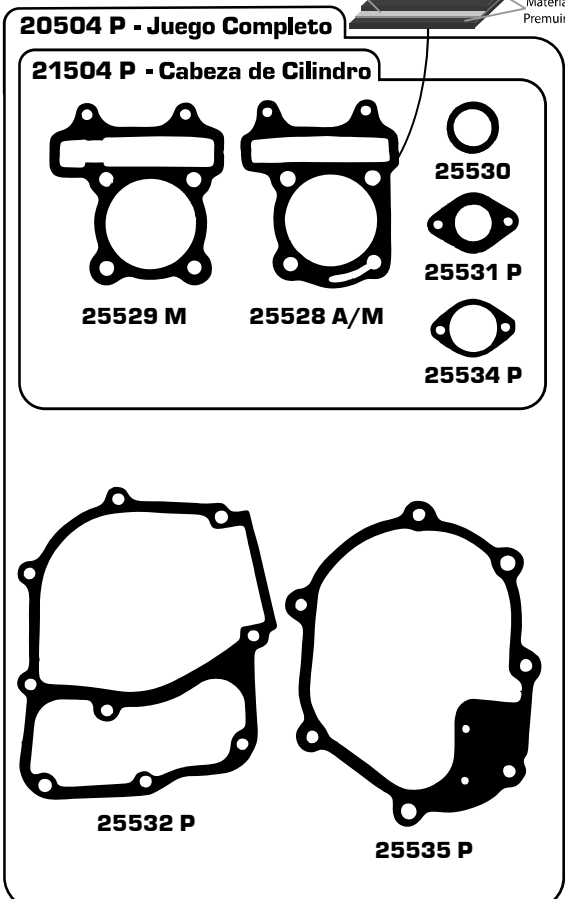

00056 P - GUERRERO GMX 150 (CUSTOM)

Bases de Cil. ALMA METAL
incluidas en las líneas
PREMIUM y PREMIUM C/O RING



EQUIVALENTES
BETA: BK 150
CERRO: PRINCE 150 (CAD.)
KAYAK: 150
MOTOMEL: CUSTOM 150 (CAD.)

CODIGO	UNIDAD	MATERIAL
00056 P	JUEGO COMPLETO	PREMIUM
00056 P/O	JUEGO COMPLETO	PREMIUM C/O RING
00678 P	CABEZA DE CILINDRO	PREMIUM
00678 P/O	CABEZA DE CILINDRO	PREMIUM C/O RING
01327 A/M	BASE DE CILINDRO	ALMA METAL
01328 A	TAPA DE CILINDRO	MFT
01328 M	TAPA DE CILINDRO	METAL
01329	ESCAPE	CHAPA
02025 P	TENSOR CADENA	PREMIUM
01330 P	EMBRAGUE	PREMIUM
01331 P	CARTER	PREMIUM
01332 P	ENCENDIDO CHICO	PREMIUM
01333 P	ENCENDIDO IZQ.	PREMIUM
01348 P	ARBOL DE LEVAS	PREMIUM
01334 P	CENTRIFUGO ACEITE	PREMIUM
01349	BOMBA ACEITE	ADAMITE
9-643	KIT O RING COMPLETO	NITRILO
8-643	KIT O RING CABEZA CIL.	NITRILO

00056 P - Juego completo

00678 P - Cabeza de Cilindro

01328 A

01327 A/M

02025 P

01333 P

01348 P

01334 P

01349

01332 P

01330 P

01331 P

9-643 - Kit O ring Completo

8-643 - Kit O ring Cabeza Cil.

20452 P - GUERRERO GR1 200

Bases de Cil. ALMA METAL
incluidas en las líneas
PREMIUM y PREMIUM C/O RING

EQUIVALENTES

GUERRERO: GR5 230

CODIGO	UNIDAD	MATERIAL
20452 P	JUEGO COMPLETO	PREMIUM
20452 P/O	JUEGO COMPLETO	PREMIUM C/O RING
21452 P	CABEZA DE CILINDRO	PREMIUM
21452 P/O	CABEZA DE CILINDRO	PREMIUM C/O RING
25386 A/M	BASE DE CILINDRO	ALMA METAL
25387 M	TAPA DE CILINDRO	METAL
25388	ESCAPE	CHAPA
25389 P	ADMISION	PREMIUM
25390 P	TENSOR CADENA	PREMIUM
25391 P	T/CENT. ACEITE	PREMIUM
25392 P	T/ARBOL DE LEVAS	PREMIUM
25393 P	EMBRAGUE	PREMIUM
25394 P	ENCENDIDO	PREMIUM
25395 P	CARTER	PREMIUM
9-648	KIT O RING COMPLETO	NITRILO
8-648	KIT O RING CAB. CIL.	NITRILO

20452 P - Juego Completo

21452 P - Cabeza de Cilindro



25387 M

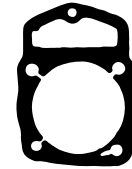

25386 A/M



25388



25389 P



25390 P

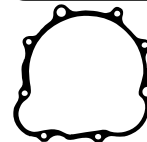

25394 P

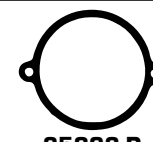

25392 P



25391 P

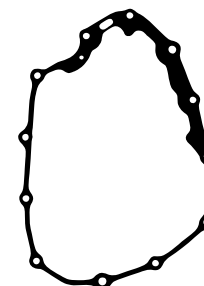

25393 P

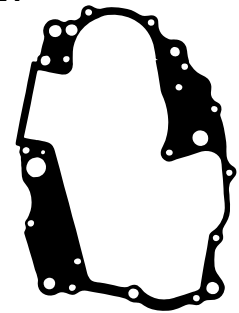

25395 P

Metal
Material
Premium

9-648 - Kit O ring Completo

8-648 - Kit O ring Cabeza Cil.

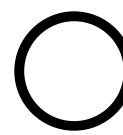

12-121



12-112

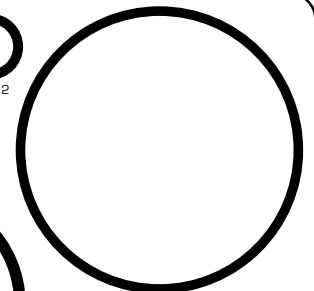

12-151

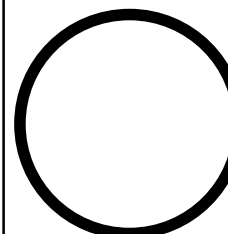

12-126



12-012



12-012

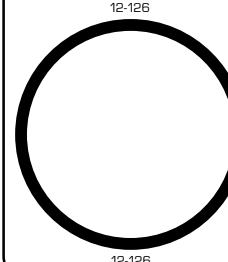

12-126

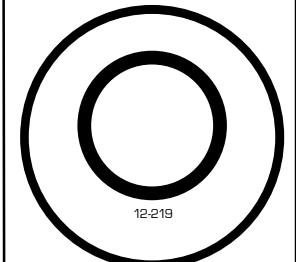

12-219

12-146



Motos y Cuatriciclos

20027 P - GUERRERO 200 TUNDRA (BAL.)

Bases de Cil. ALMA METAL
incluidas en las líneas
PREMIUM y PREMIUM C/O RING



EQUIVALENTES
GILERA: SAHER 200 (VAR.BAL.LARGO)- SMX 200 (VAR.BAL.LARGO)
GUERRERO: GMX 200 MOTARD (BAL.)
MAVERICK: DUAL 200 MOTARD (BAL.) / MONDIAL: TD 200
MOTOMEL: DAKAR 200 / ZANELLA: RX 200 NAKED

CODIGO	UNIDAD	MATERIAL
20027 P	JUEGO COMPLETO	PREMIUM C/T. VALV.
20027 P/O	JUEGO COMPLETO	PREM. C/O'RING Y T/V
21044 P	CABEZA DE CILINDRO	PREMIUM
21044 P/O	CABEZA DE CILINDRO	PREM. C/O'RING Y T/V
23024 A/M	BASE DE CILINDRO	ALMA METAL
23025 M	TAPA DE CILINDRO	METAL
23026	ESCAPE	CHAPA
23027 P	ADMISION (2 X JGO)	PREMIUM
23028 P	EMBRAGUE	PREMIUM
23029 P	CARTER	PREMIUM
23030	BOMBA ACEITE	ADAMITE
23032 P	ENCENDIDO IZQ.	PREMIUM
23034 P	CENTRIFUGO ACEITE	PREMIUM
12-7545	TAPA DE VÁLVULAS	NITRILO
9-642	KIT O'RING COMPLETO	NITRILO
8-642	KIT O'RING CABEZA CIL.	NITRILO

20027 P - Juego completo

21044 P - Cabeza de Cilindro

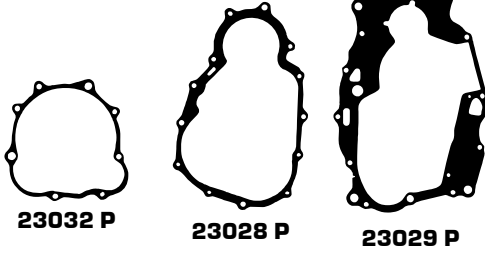
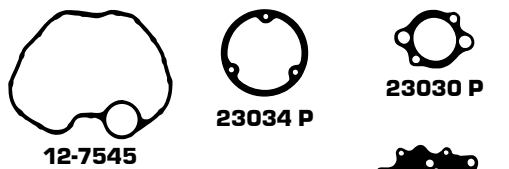
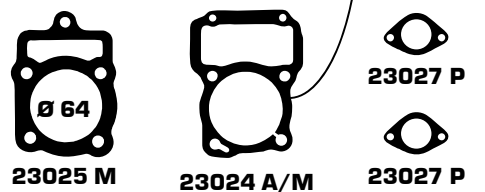

9-642 - Kit O´ring Completo

8-642 - Kit O´ring Cabeza Cil.

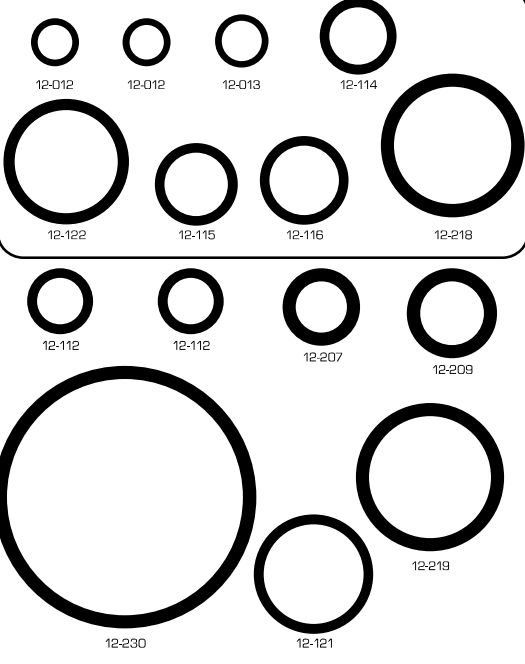

00101 P - HONDA BIZ C 100

EQUIVALENTES
HONDA: WAVE 100 NF - POP 100
GUERRERO: GD 100

CODIGO	UNIDAD	MATERIAL
00101 P	JUEGO COMPLETO	PREMIUM
00101 P/O	JUEGO COMPLETO	PREMIUM C/O'RING
00554 P	CABEZA DE CILINDRO	PREMIUM
00554 P/O	CABEZA DE CILINDRO	PREMIUM C/O'RING
01532 A/M	BASE DE CILINDRO	ALMA METAL
01533 A	TAPA DE CILINDRO	MFT
01533 M	TAPA DE CILINDRO	METAL
01534	ESCAPE	CHAPA
01535 P	ADMISION AL CIL.	PREMIUM
01535 S	ADMISION AL CARB.	PREMIUM
01536 P	EMBRAGUE	PREMIUM
01537 P	CARTER	PREMIUM
01538	BOMBA ACEITE	ADAMITE
01539 P	ENCENDIDO	PREMIUM
01558 P	T/CABEZA DE CIL.	PREMIUM
01559 P	T/DISTRIBUCION	PREMIUM
01560 P	LATERAL DERECHO	PREMIUM
01561	FILTRO ACEITE	ADAMITE
01557 P	CENTRIFUGO ACEITE	PREMIUM
9-605	KIT O'RING COMPLETO	NITRILO
8-605	KIT O'RING CABEZA CIL.	NITRILO
9-638	KIT O'RING TAPA CIL.	NITRILO

00101 P - Juego completo

00554 P - Cabeza de Cilindro

Bases de Cil. ALMA METAL incluidas en las líneas PREMIUM y PREMIUM C/O'RING

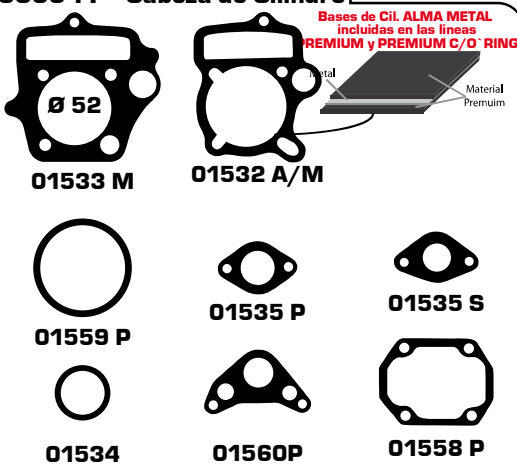

01533 M 01532 A/M

01559 P 01535 P 01535 S

01534 01560P 01558 P

01561 01538 01557 P

01539 P 01536 P 01537 P

9-605 - Kit O'ring Completo

8-605 - Kit O'ring Cabeza Cil.

9-638 - Kit O'ring Tapa de Cil.

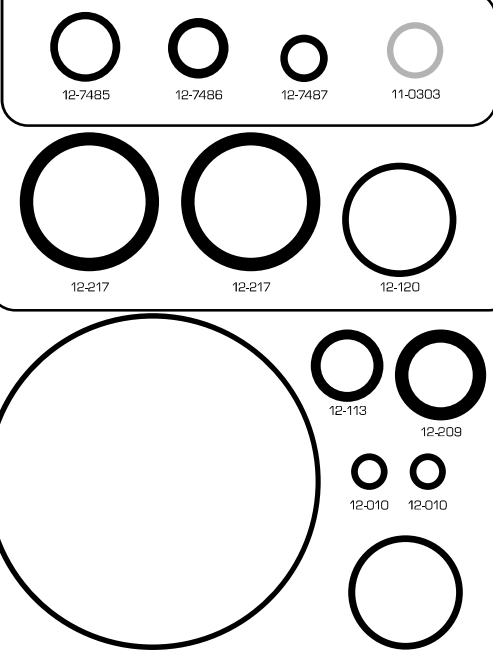

12-7485 12-7486 12-7487 11-0303

12-217 12-217 12-120

12-113 12-209

12-010 12-010

12-046 12-023

00109 P - HONDA HERO CD 100

EQUIVALENTES

GILERA: QM 100 - 9

GUERRERO: G 100 - WG BIKE 100

NANFANG: JIMNA FN 100

CODIGO	UNIDAD	MATERIAL
00109 P	JUEGO COMPLETO	PREMIUM
00109 P/O	JUEGO COMPLETO	PREMIUM C/O'RING
00567 P	CABEZA DE CILINDRO	PREMIUM
00567 P/O	CABEZA DE CILINDRO	PREMIUM C/O'RING
01562 A/M	BASE DE CILINDRO	ALMA METAL
01563 A	TAPA DE CILINDRO	MFT
01563 M	TAPA DE CILINDRO	METAL
01564	ESCAPE	CHAPA
01565 P	ADMISION AL CIL.	PREMIUM
01565 S	ADMISION AL CARB.	PREMIUM
01566 P	EMBRAGUE	PREMIUM
01567 P	CARTER	PREMIUM
01569	BOMBA ACEITE	ADAMITE
01570 P	ENCENDIDO	PREMIUM
01568 P	T/CABEZA DE CIL.	PREMIUM
01571 P	T/DISTRIBUCION	PREMIUM
01572 P	LATERAL DERECHO	PREMIUM
01573	FILTRO ACEITE	ADAMITE
01509 P	CENTRIFUGO ACEITE	PREMIUM
9-605	KIT O'RING COMPLETO	NITRILO
8-605	KIT O'RING CABEZA CIL.	NITRILO
9-638	KIT O'RING TAPA CIL.	NITRILO

00109 P - Juego completo

00567 P - Cabeza de Cilindro

Bases de Cil. ALMA METAL
incluidas en las líneas
PREMIUM y PREMIUM C/O' RING

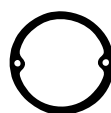
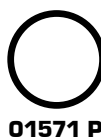

9-605 - Kit O'ring Completo

8-605 - Kit O'ring Cabeza Cil.

9-638 - Kit O'ring Tapa de Cil.

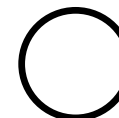
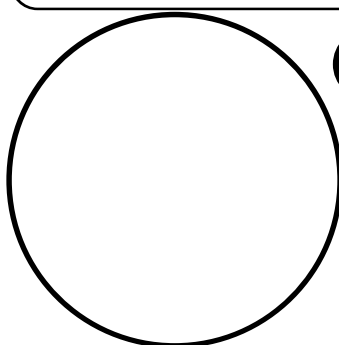
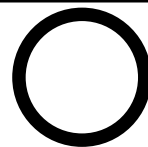

20310 P - HONDA WAVE 110 S

Bases de Cil. ALMA METAL
incluidas en las líneas PREMIUM



EQUIVALENTES		

CODIGO	UNIDAD	MATERIAL
20310 P	JUEGO COMPLETO	PREMIUM
21310 P	CABEZA DE CILINDRO	PREMIUM
25000 A/M	BASE DE CILINDRO	ALMA METAL
25001 A	TAPA DE CILINDRO	MFT
25001 M	TAPA DE CILINDRO	METAL
25002	ESCAPE	CHAPA
25003 P	TENSOR CADENA	PREMIUM
25004 P	CENTRIFUGO ACEITE	PREMIUM
25005 P	EMBRAGUE	PREMIUM
25006 P	ENCENDIDO	PREMIUM
25007 P	CARTER	PREMIUM
01538	FILTRO ACEITE	ATE.
12-7755	TAPA DE VÁLVULAS	NITRILO

20310 P - Juego completo

21310 P - Cabeza de Cilindro

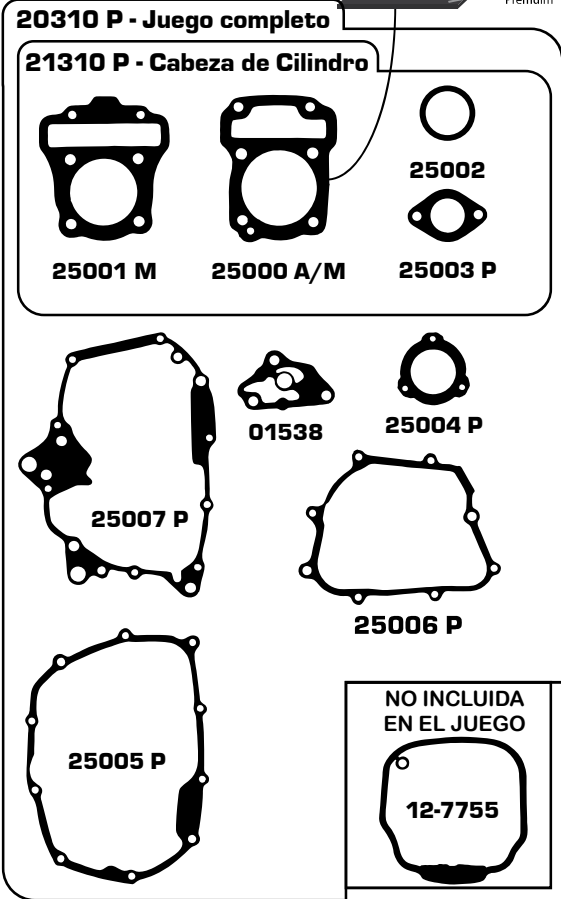

25001 M 25000 A/M 25003 P

25007 P 01538 25004 P

25006 P

25005 P

NO INCLUIDA EN EL JUEGO

12-7755

20344 P - HONDA CB1 125

Bases de Cil. ALMA METAL
incluidas en las líneas PREMIUM

EQUIVALENTES

HONDA: CB 125 F TWISTER

20344 P - Juego completo

21344 P - Cabeza de Cilindro

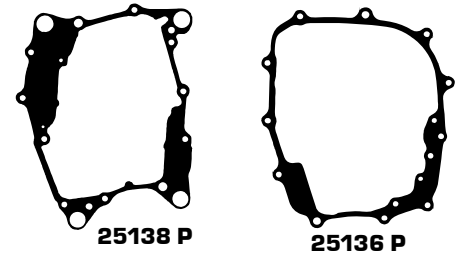
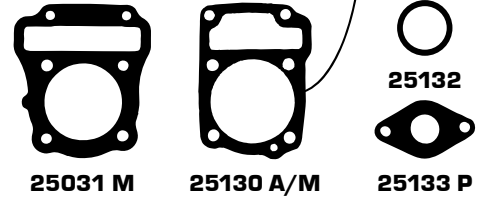

CODIGO	UNIDAD	MATERIAL
20344 P	JUEGO COMPLETO	PREMIUM C/T. VALV.
21344 P	CABEZA DE CILINDRO	PREMIUM C/T. VALV.
25130 A/M	BASE DE CILINDRO	ALMA METAL
25131 M	TAPA DE CILINDRO	METAL
25132	ESCAPE	CHAPA
25133 P	ADMISION	PREMIUM
25134 P	COMPENSACION	PREMIUM
25135 P	BOMBA ACEITE	PREMIUM
25136 P	EMBRAGUE	PREMIUM
25137 P	ALTERNADOR	PREMIUM
25138 P	CARTER	PREMIUM
12-7594	T/DISTRIBUCION	NITRILO
12-7754	TAPA DE VÁLVULAS	NITRILO

20117 P - HONDA BIZ KS/ES 125 M. 2005

Bases de Cil. ALMA METAL
incluidas en las líneas
PREMIUM y PREMIUM C/O'RING



EQUIVALENTES

CODIGO	UNIDAD	MATERIAL
20117 P	JUEGO COMPLETO	PREMIUM
20117 P/O	JUEGO COMPLETO	PREMIUM C/O'RING
21119 P	CABEZA DE CILINDRO	PREMIUM
21119 P/O	CABEZA DE CILINDRO	PREMIUM C/O'RING
23946 A/M	BASE DE CILINDRO	ALMA METAL
23947 A	TAPA DE CILINDRO	MFT
23947 M	TAPA DE CILINDRO	METAL
23948	ESCAPE	CHAPA
23966 P	ADMISION AL CIL.	PREMIUM
23950 P	EMBRAGUE	PREMIUM
23951 P	CARTER	PREMIUM
23953 P	ENCENDIDO	PREMIUM
23954 P	T/DISTRIBUCION	PREMIUM
23952 A	ADMISION CHICA	MFT
23955 P	TENSOR CADENA	PREMIUM
8-636	KIT O'RING COMPLETO	NITRILO
9-636	KIT O'RING CABEZA CIL.	NITRILO

20117 P - Juego completo

21119 P - Cabeza de Cilindro

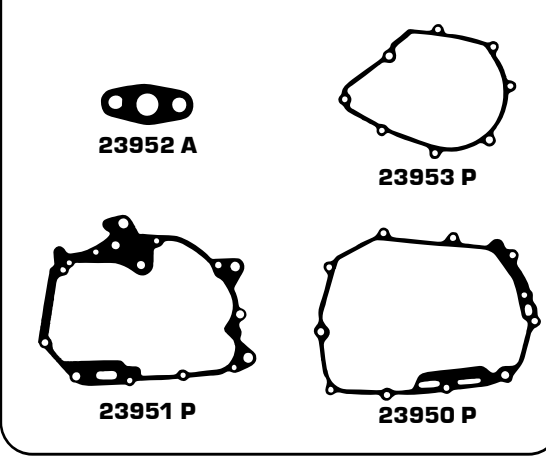
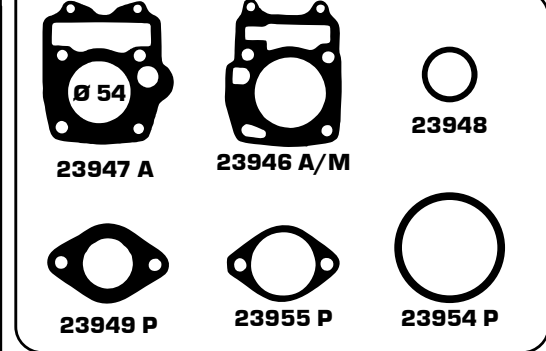

9-636 - Kit O'ring Completo

8-636 - Kit O'ring Cabeza Cil.

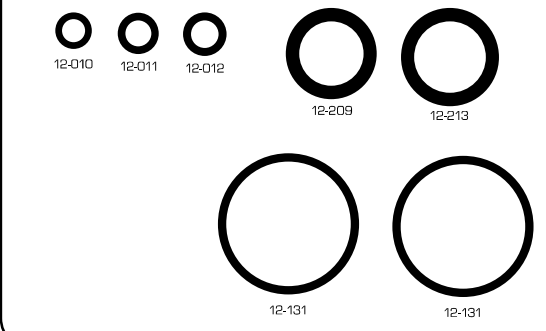
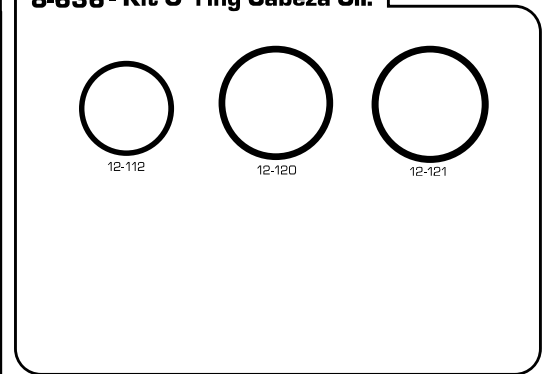



20503 P - HONDA ELITE 125 M. 2014

Bases de Cil. ALMA METAL
incluidas en las líneas
PREMIUM y PREMIUM C/O RING



EQUIVALENTES

CODIGO	UNIDAD	MATERIAL
20503 P	JUEGO COMPLETO	PREMIUM
20503 P/O	JUEGO COMPLETO	PREMIUM C/O RING
21503 P	CABEZA DE CILINDRO	PREMIUM
21503 P/O	CABEZA DE CILINDRO	PREMIUM C/O RING
25518 A/M	BASE DE CILINDRO	ALMA METAL
25518 P	BASE DE CILINDRO	PREMIUM
25519 A	TAPA DE CILINDRO	MFT
25519 M	TAPA DE CILINDRO	METAL
25520	ESCAPE	CHAPA
25521 P	ADMISION	PREMIUM
23016 P	ADMISION 2	PREMIUM
25522 P	CARTER	PREMIUM
25524 P	CADENA	PREMIUM
25525 M	TENSOR CADENA	METAL
25526 P	TRANSMISION	PREMIUM
25527 P	CARTER LATERAL	PREMIUM

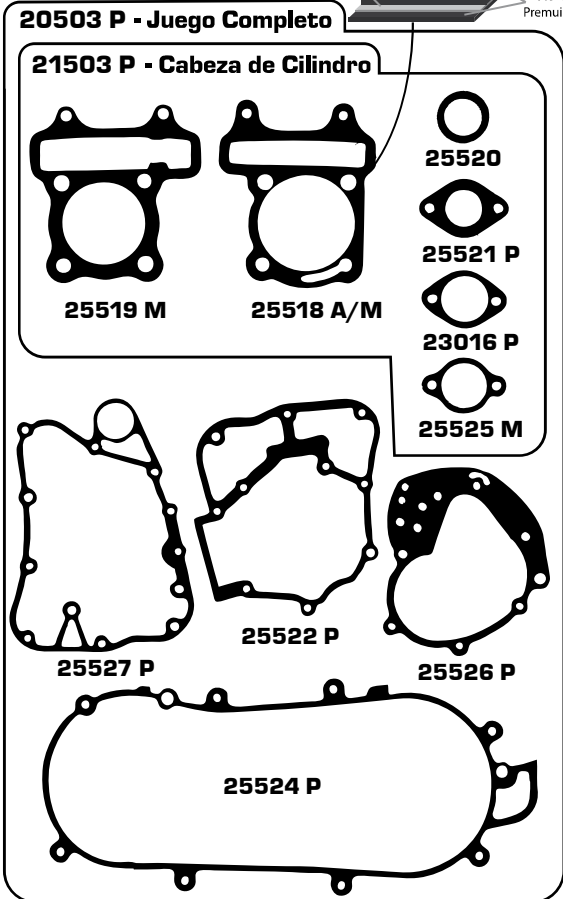

06171 P - HONDA STORM 125

Bases de Cil. ALMA METAL
incluidas en las líneas
PREMIUM y PREMIUM C/O RING



EQUIVALENTES	
HONDA: XR 125 MOD. 2012	

CODIGO	UNIDAD	MATERIAL
06171 P	JUEGO COMPLETO	PREMIUM C/T. VALV.
06171 P/O	JUEGO COMPLETO	PREM. C/O'RING Y T/V
06447 P	CABEZA DE CILINDRO	PREMIUM
06447 P/O	CABEZA DE CILINDRO	PREM. C/O'RING Y T/V
08866 A/M	BASE DE CILINDRO	ALMA METAL
23046 M	TAPA DE CILINDRO	METAL
23047	ESCAPE	CHAPA
23048 P	ADMISION	PREMIUM
23049 P	CARTER	PREMIUM
08867 P	EMBRAGUE	PREMIUM
23050	BOMBA ACEITE	ADAMITE
08868 P	ENCENDIDO IZQ.	PREMIUM
23053 P	T/CENT. ACEITE	PREMIUM
12-7545	TAPA VALVULAS	NITRILO
9-642	KIT O'RING COMPLETO	NITRILO
8-642	KIT O'RING CABEZA CIL.	NITRILO

06171 P - Juego completo

06447 P - Cabeza de Cilindro

Ø 60

23046 M 08866 A/M 23047

23048 P

12-7545 23053 P 23050

08868 P 08867 P 23049 P

9-642 - Kit O ring Completo

8-642 - Kit O ring Cabeza Cil.

12-012 12-012 12-013 12-114

12-122 12-115 12-116 12-218

12-112 12-112 12-207 12-209

12-230 12-121 12-219

06027 P - HONDA TITAN 125 M. 2000

Bases de Cil. ALMA METAL
incluidas en las líneas
PREMIUM y PREMIUM C/O RING



EQUIVALENTES	
HONDA:	BROSS 125 - FAN 125
ZANELLA:	HJ 125

CODIGO	UNIDAD	MATERIAL
06027 P	JUEGO COMPLETO	PREMIUM C/T. VALV.
06027 P/O	JUEGO COMPLETO	PREM. C/O'RING Y T/V
06284 P	CABEZA DE CILINDRO	PREMIUM
06284 P/O	CABEZA DE CILINDRO	PREM. C/O'RING Y T/V
06705 A/M	BASE DE CILINDRO	ALMA METAL
06706 M	TAPA DE CILINDRO	METAL
06707	ESCAPE	CHAPA
06708 P	ADMISION (2 X JGO)	PREMIUM
06709 P	EMBRAGUE	PREMIUM
06710 P	CARTER	PREMIUM
06712	BOMBA ACEITE	ADAMITE
06714 P	ENCENDIDO IZQ.	PREMIUM
06711 P	T/CENT. ACEITE	PREMIUM
12-7545	TAPA DE VÁLVULAS	NITRILO
9-608	KIT O'RING COMPLETO	NITRILO
8-608	KIT O'RING CABEZA CIL.	NITRILO

06027 P - Juego completo

06284 P - Cabeza de Cilindro



06706 M



06705 A/M



23048 P



06707



06708 P



06708 P



12-7545



06711 P



06712

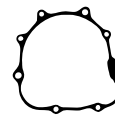

06714 P

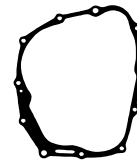

06709 P

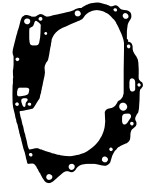

06710 P

9-608 - Kit O´ring Completo

8-608 - Kit O´ring Cabeza Cil.



12-011



12-117

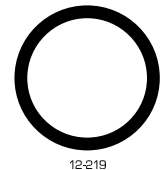

12-219



12-012



12-012



12-115



12-207



12-209

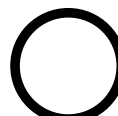

12-121

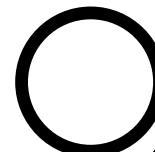

12-220

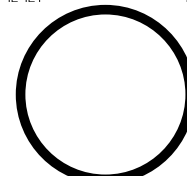

12-132

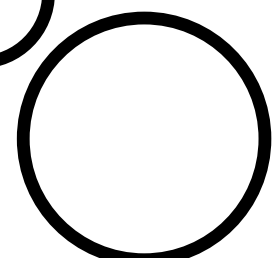

12-230

00121 P - HONDA TODAY 125

Bases de Cil. ALMA METAL
incluidas en las líneas
PREMIUM y PREMIUM C/O RING



EQUIVALENTES	
HONDA:	XLR 125
GILERA:	GA 125
GUERRERO:	GC 125
KYMCO:	SECTOR 125

CODIGO	UNIDAD	MATERIAL
00121 P	JUEGO COMPLETO	PREMIUM C/T. VALV.
00121 P/O	JUEGO COMPLETO	PREM. C/O'RING Y T/V
00578 P	CABEZA DE CILINDRO	PREMIUM
00578 P/O	CABEZA DE CILINDRO	PREM. C/O'RING Y T/V
06690 A/M	BASE DE CILINDRO	ALMA METAL
06691 A	TAPA DE CILINDRO	MFT
00692	ESCAPE	CHAPA
06693 P	ADMISION (2 X JGO)	PREMIUM
06694 P	EMBRAGUE	PREMIUM
06695 P	CARTER	PREMIUM
06697	BOMBA ACEITE	ADAMITE
06699 P	ENCENDIDO IZQ.	PREMIUM
06696 P	T/CENT. ACEITE	PREMIUM
12-7545	TAPA DE VÁLVULAS	NITRILO
9-641	KIT O'RING COMPLETO	NITRILO
8-641	KIT O'RING CABEZA CIL.	NITRILO

00121 P - Juego completo

00578 P - Cabeza de Cilindro



06691 A



06690 A/M



06692



06693 P



06693 P



12-7545



06696 P



06697



06699 P

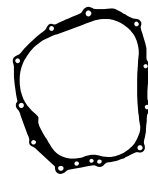

06694 P



06695 P

9-641 - Kit O´ring Completo

8-641 - Kit O´ring Cabeza Cil.



12-011



12-117

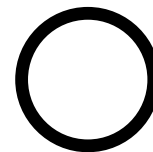

12-219



12-012



12-012



12-207



12-209



12-115

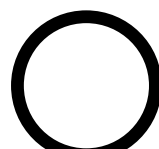

12-220

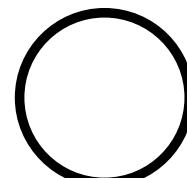

12-132

20311 P - HONDA XR 125 R M. 2013

Bases de Cil. ALMA METAL
incluidas en las líneas
PREMIUM y PREMIUM C/O'RING



EQUIVALENTES

HONDA: XR 125 L M.2013

CODIGO	UNIDAD	MATERIAL
20311 P	JUEGO COMPLETO	PREMIUM C/T. VALV.
20311 P/O	JUEGO COMPLETO	PREM. C/O'RING Y T/V
21311 P	CABEZA DE CILINDRO	PREMIUM
21311 P/O	CABEZA DE CILINDRO	PREM. C/O'RING Y T/V
08152 A/M	BASE DE CILINDRO	ALMA METAL
25128 M	TAPA DE CILINDRO	METAL
25128 A	TAPA DE CILINDRO	MFT
08154	ESCAPE	CHAPA
06693 P	ADMISION (2 X JGO)	PREMIUM
08155 P	EMBRAGUE	PREMIUM
08156 P	CARTER	PREMIUM
08157 P	ENCENDIDO	PREMIUM
08158 M	TENSOR CADENA	METAL
08159 P	T/CENT. ACEITE	PREMIUM
12-7650	TAPA DE VÁLVULAS	NITRILO
9-631	KIT O'RING COMPLETO	NITRILO
8-631	KIT O'RING CABEZA CIL.	NITRILO

20311 P - Juego completo

21311 P - Cabeza de Cilindro

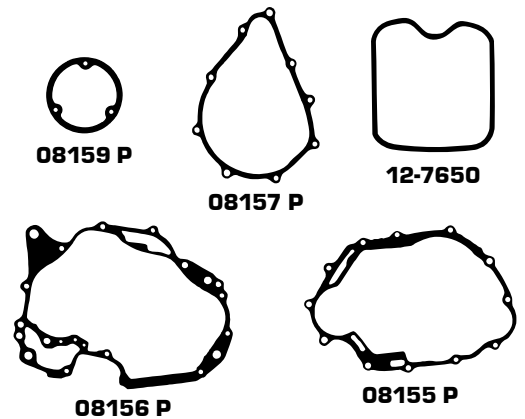
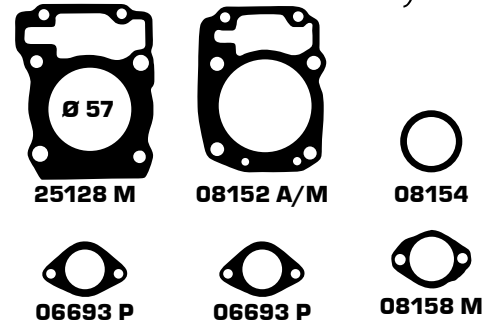

9-631 - Kit O´ring Completo

8-631 - Kit O´ring Cabeza Cil.

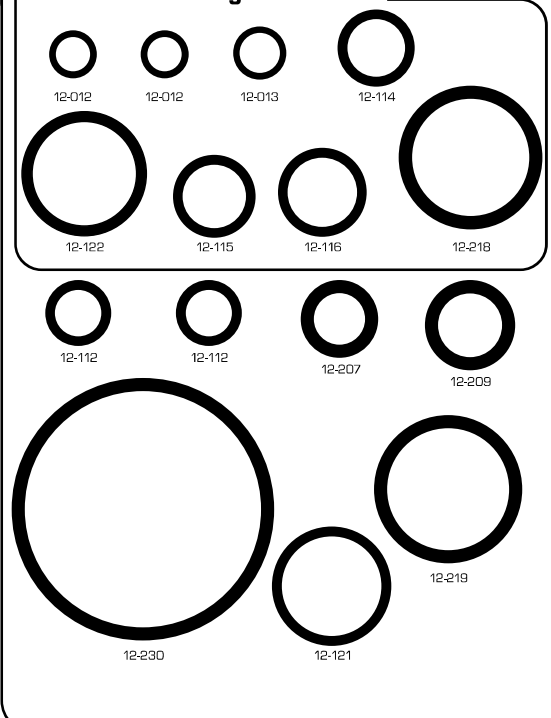



06141 P - HONDA CG 150 TITAN

Bases de Cil. ALMA METAL
incluidas en las líneas
PREMIUM y PREMIUM C/O RING



EQUIVALENTES

APPIA: BREZZA EURO 150
HONDA: INVICTA CB 150 - XR 150 L
GILERA: VC 150 R
MOTOMEL: SIRIUS 150

CODIGO	UNIDAD	MATERIAL
06141 P	JUEGO COMPLETO	PREMIUM C/T. VALV.
06141 P/O	JUEGO COMPLETO	PREM. C/O'RING Y T/V
06417 P	CABEZA DE CILINDRO	PREMIUM
06417 P/O	CABEZA DE CILINDRO	PREM. C/O'RING Y T/V
08152 A/M	BASE DE CILINDRO	ALMA METAL
08153 M	TAPA DE CILINDRO	METAL
08153 A	TAPA DE CILINDRO	MFT
08154	ESCAPE	CHAPA
06693 P	ADMISION (2 X JGO)	PREMIUM
08155 P	EMBRAGUE	PREMIUM
08156 P	CARTER	PREMIUM
08157 P	ENCENDIDO	PREMIUM
08158 M	TENSOR CADENA	METAL
08159 P	T/CENT. ACEITE	PREMIUM
12-7650	TAPA DE VÁLVULAS	NITRILO
9-631	KIT O'RING COMPLETO	NITRILO
8-631	KIT O'RING CABEZA CIL.	NITRILO

06141 P - Juego completo

06417 P - Cabeza de Cilindro

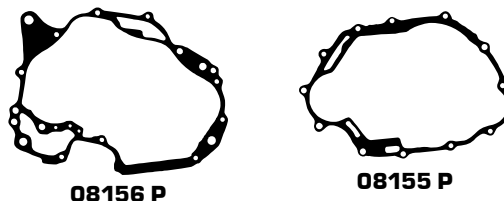
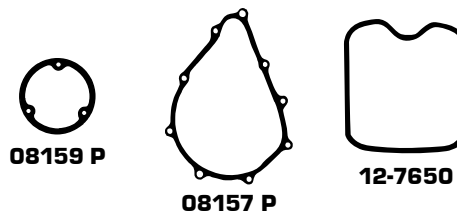
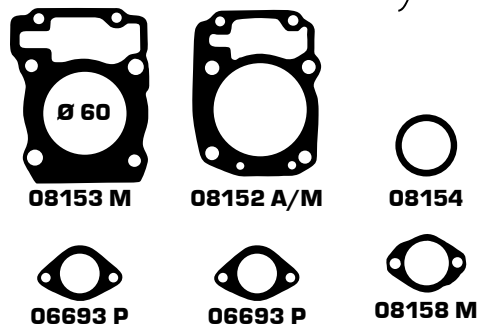

9-631 - Kit O'ring Completo

8-631 - Kit O'ring Cabeza Cil.

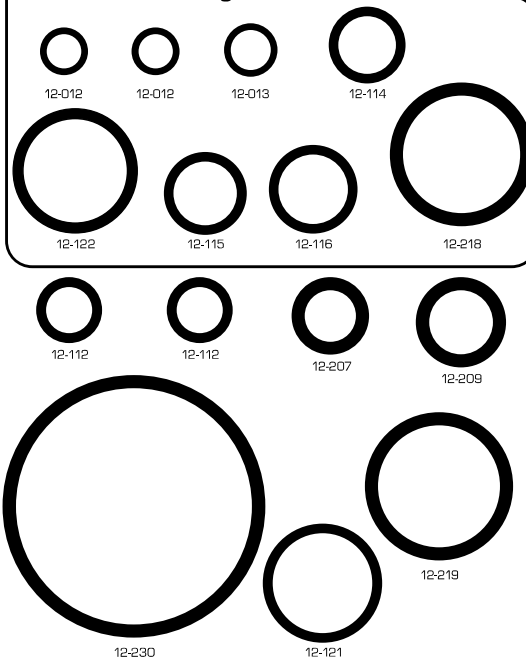

00127 P - HONDA NX 150

Bases de Cil. ALMA METAL
incluidas en las líneas
PREMIUM y PREMIUM C/O´RING



EQUIVALENTES

HONDA: AERO CBX 150
ZANELLA: RX 150 (CAD.)

CODIGO	UNIDAD	MATERIAL
00127 P	JUEGO COMPLETO	PREMIUM
00127 P/O	JUEGO COMPLETO	PREMIUM C/O´RING
00586 P	CABEZA DE CILINDRO	PREMIUM
00586 P/O	CABEZA DE CILINDRO	PREMIUM C/O´RING
01706 A/M	BASE DE CILINDRO	ALMA METAL
01707 A	TAPA DE CILINDRO	MFT
01707 M	TAPA DE CILINDRO	METAL
01644	ESCAPE	CHAPA
02025 P	TENSOR CADENA	PREMIUM
01645 P	EMBRAGUE	PREMIUM
01646 P	CARTER	PREMIUM
01639 P	ENCENDIDO CHICO	PREMIUM
01647 P	ENCENDIDO IZQ.	PREMIUM
01641 P	ARBOL DE LEVAS	PREMIUM
01640 P	T/CENT. ACEITE	PREMIUM
23307	BOMBA ACEITE	ADAMITE
9-614	KIT O´RING COMPLETO	NITRILO
8-614	KIT O´RING CABEZA CIL.	NITRILO

00127 P - Juego completo

00586 P - Cabeza de Cilindro

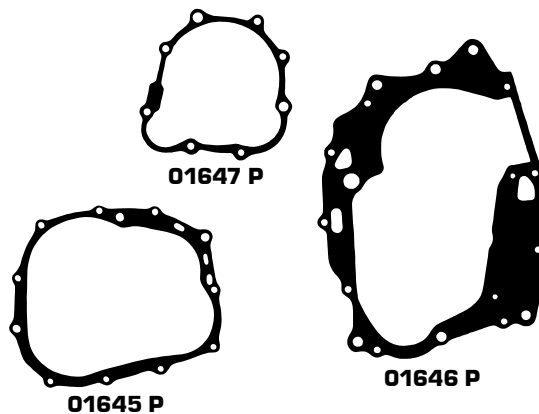
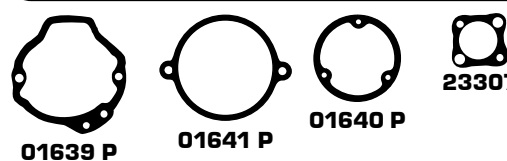
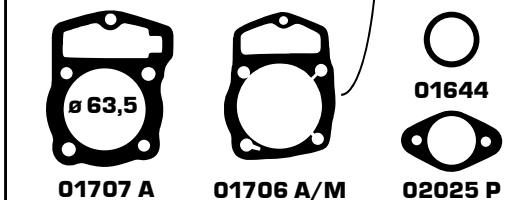

9-614 - Kit O´ring Completo

8-614 - Kit O´ring Cabeza Cil.

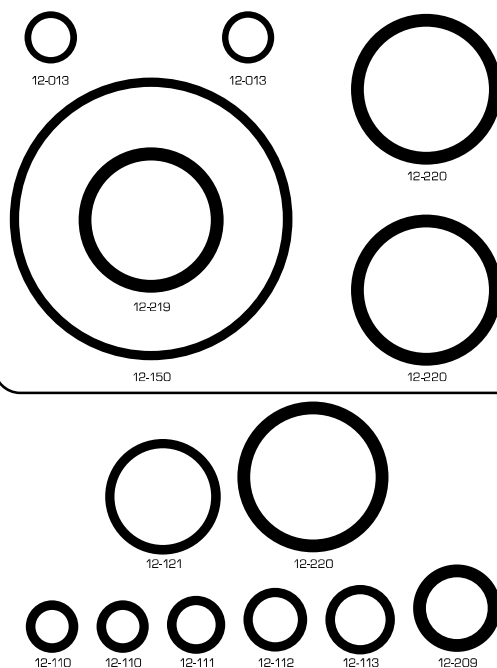



00136 P - HONDA XR 200 (JAPÓN)

Bases de Cil. ALMA METAL
incluidas en las líneas
PREMIUM y PREMIUM C/O'RING

EQUIVALENTES
HONDA: NX 200 (JAPÓN) - STRADA CBX 200 (JAPÓN)

CODIGO	UNIDAD	MATERIAL
00136 P	JUEGO COMPLETO	PREMIUM
00136 P/O	JUEGO COMPLETO	PREMIUM C/O'RING
00594 P	CABEZA DE CILINDRO	PREMIUM
00594 P/O	CABEZA DE CILINDRO	PREMIUM C/O'RING
01781 A/M	BASE DE CILINDRO	ALMA METAL
01782 A	TAPA DE CILINDRO	MFT
01785	ESCAPE	CHAPA
02025 P	TENSOR CADENA	PREMIUM
01783 P	EMBRAGUE	PREMIUM
01784 P	CARTER	PREMIUM
01787 P	ENCENDIDO CHICO	PREMIUM
01798 P	ENCENDIDO IZQ.	PREMIUM
01786 P	ARBOL DE LEVAS	PREMIUM
01779 P	T/CENT. ACEITE	PREMIUM
23307	BOMBA ACEITE	ADAMITE
9-614	KIT O'RING COMPLETO	NITRILO
8-614	KIT O'RING CABEZA CIL.	NITRILO



00136 P - Juego completo

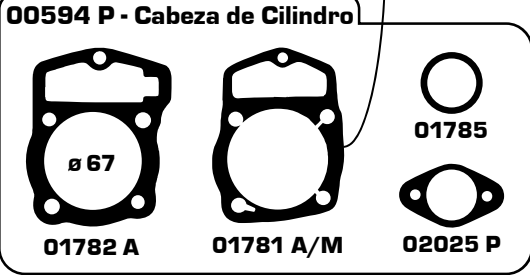

00594 P - Cabeza de Cilindro

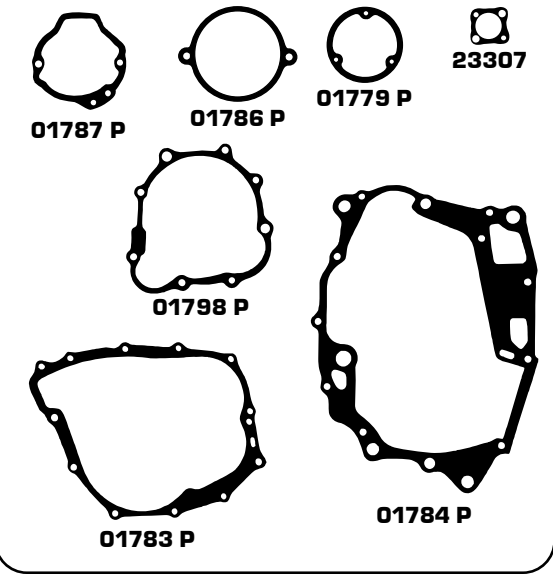

9-614 - Kit O'ring Completo

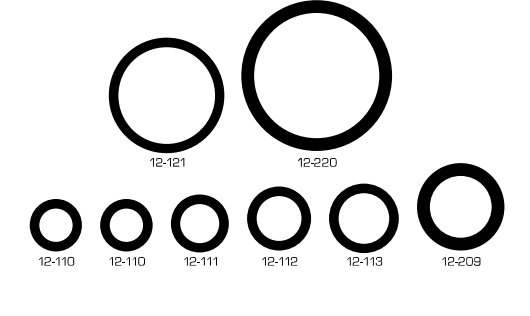
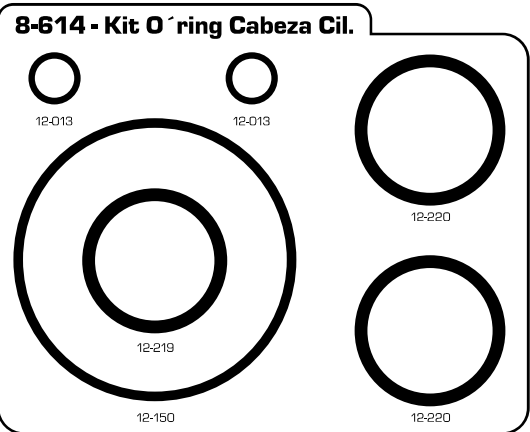

06143 P - HONDA XR 200 (BRASIL)

Bases de Cil. ALMA METAL
incluidas en las líneas
PREMIUM y PREMIUM C/O'RING



EQUIVALENTES	
HONDA: NX 200 (BRASIL) - STRADA CBX 200 (BRASIL)	

CODIGO	UNIDAD	MATERIAL
06143 P	JUEGO COMPLETO	PREMIUM
06143 P/O	JUEGO COMPLETO	PREMIUM C/O'RING
21066 P	CABEZA DE CILINDRO	PREMIUM
21066 P/O	CABEZA DE CILINDRO	PREMIUM C/O'RING
23412 A/M	BASE DE CILINDRO	ALMA METAL
23413 M	TAPA DE CILINDRO	METAL
23414	ESCAPE	CHAPA
02025 P	TENSOR CADENA	PREMIUM
08163 P	EMBRAGUE	PREMIUM
23415 P	CARTER	PREMIUM
23416 P	ENCENDIDO CHICO	PREMIUM
23417 P	ENCENDIDO IZQ.	PREMIUM
23418 P	ARBOL DE LEVAS	PREMIUM
23419 P	T/CENT. ACEITE	PREMIUM
23307	BOMBA ACEITE	ADAMITE
9-614	KIT O'RING COMPLETO	NITRILO
8-614	KIT O'RING CABEZA CIL.	NITRILO

06143 P - Juego completo

21066 P - Cabeza de Cilindro

23413 M 23412 A/M 23414
 02025 P

23416 P 23418 P 23419 P 23307

08163 P 23415 P

9-614 - Kit O'ring Completo

8-614 - Kit O'ring Cabeza Cil.

12-013 12-013 12-220
 12-219
 12-150 12-220

12-121 12-220

12-110 12-110 12-111 12-112 12-113 12-209

20502 P - HONDA 250 CB TWISTER 2018/9 INY.

EQUIVALENTES

CODIGO	UNIDAD	MATERIAL
20502 P	JUEGO COMPLETO	PREMIUM
21502 P	CABEZA DE CILINDRO	PREMIUM
25512 A/M	BASE DE CILINDRO	ALMA METAL
25512 P	BASE DE CILINDRO	PREMIUM
25513 A	TAPA DE CILINDRO	MFT
25513 M	TAPA DE CILINDRO	METAL
25514	ESCAPE	CHAPA
25515 P	EMBRAGUE	PREMIUM
25516 P	ENCENDIDO	PREMIUM
25517 M	TENSOR	PREMIUM

20502 P - Juego Completo

Bases de Cil. ALMA METAL incluidas en las líneas PREMIUM y PREMIUM C/O RING

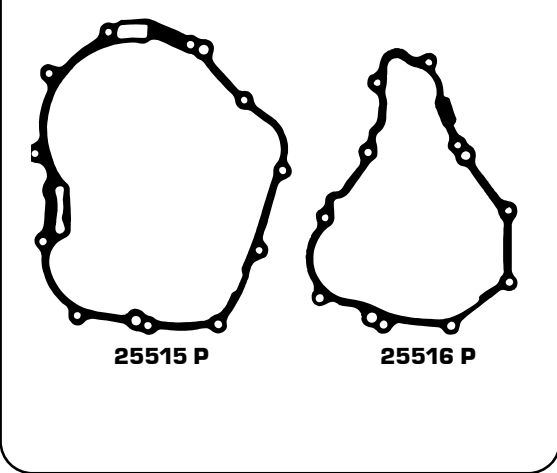



Motos y Cuatriciclos

20561 P - HONDA CR 250 M.2006

Bases de Cil. ALMA METAL
incluidas en las líneas
PREMIUM y PREMIUM C/O RING



EQUIVALENTES	

20561 P - Juego Completo

21561 P - Cabeza de Cilindro

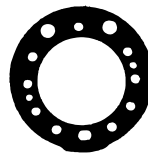

25661 A

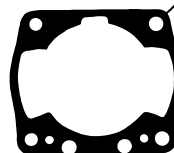

25660 A/M

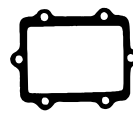

25662 P

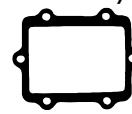

25662 P

CODIGO	UNIDAD	MATERIAL
20561 P	JUEGO COMPLETO	PREMIUM
21561 P	CABEZA DE CILINDRO	PREMIUM
25660 A/M	BASE DE CILINDRO	ALMA METAL
25661 A	TAPA DE CILINDRO	MFT
25662 P	FLAPPERS	PREMIUM
25663 P	EMBRAGUE	PREMIUM
25664 P	CARTER	PREMIUM

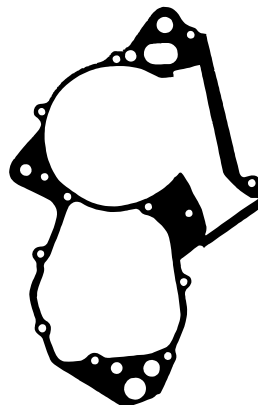

25664 P

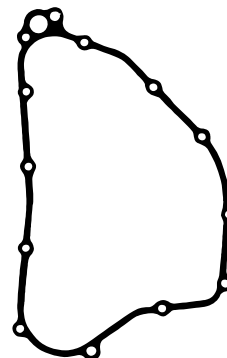

25663 P

06227 P - HONDA TORNADO 250

Bases de Cil. ALMA METAL
incluidas en las líneas
PREMIUM y PREMIUM C/O'RING



EQUIVALENTES

HONDA: CBX 250 TWISTER

CODIGO	UNIDAD	MATERIAL
06227 P	JUEGO COMPLETO	PREMIUM
06227 P/O	JUEGO COMPLETO	PREM. C/O'RING
06236 P	CABEZA DE CILINDRO	PREMIUM
06236 P/O	CABEZA DE CILINDRO	PREM. C/O'RING
23476 A/M	BASE DE CILINDRO	ALMA METAL
23477 A	TAPA DE CILINDRO	MFT
23477 M	TAPA DE CILINDRO	METAL
23478	ESCAPE	CHAPA
25620 P	TUBO ADMISION	PREMIUM
23479 P	EMBRAGUE	PREMIUM
23480 P	CARTER	PREMIUM
23481 P	ALTERNADOR	PREMIUM
23482 M	TENSOR CADENA	METAL
12-7753	TAPA DE VÁLVULAS	NITRILO
9-617	KIT O'RING COMPLETO	NITRILO
8-617	KIT O'RING CABEZA CIL.	NITRILO

06143 P - Juego completo

21066 P - Cabeza de Cilindro

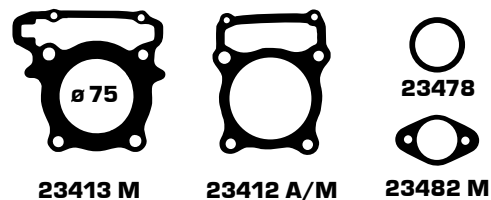

23413 M

23412 A/M

23478

23482 M

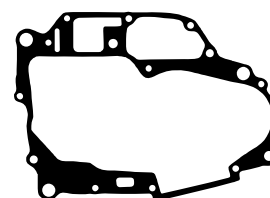

23480 P

25620 P

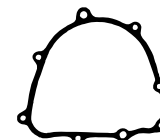

23481 P

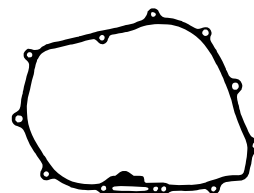

23479 P



12-7753

9-617 - Kit O'ring Completo

8-617 - Kit O'ring Cabeza Cil.

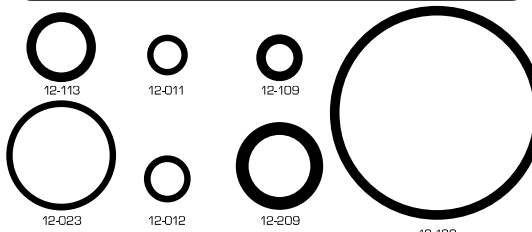
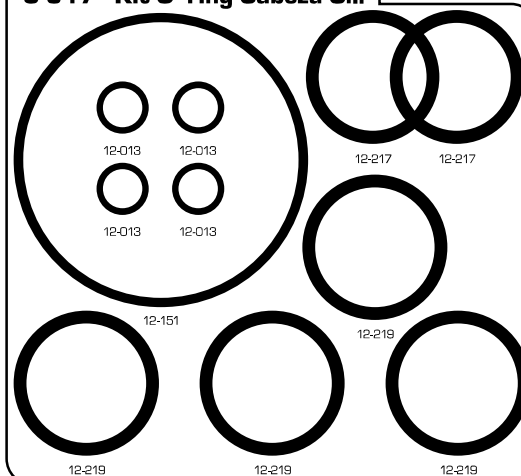

(Competición)

Tapa de Cilindro

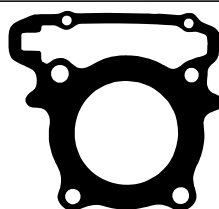

Código Diámetro

25220 - Ø 80
25366 - Ø 81
25367 - Ø 82
25221 - Ø 85
25222 - Ø 86
25223 - Ø 87
25224 - Ø 90
25225 - Ø 92
25226 - Ø 94
25227 - Ø 97

Material MFT

Código + A : Esp. 1,2
Código + B : Esp. 1,5
Código + C : Esp. 2,6

Ej: 25220 B
Tapa Cil. Tornado/Twister
Ø 80 MFT Esp. 1,5 mm
Ej: 25230 B
Base Cil. Tornado/Twister
Ø 88 MFT Esp. 1,5 mm

Base de Cilindro



Código Diámetro

25465 - Ø 83
25230 - Ø 88
25231 - Ø 99

20185 P - HONDA NX 400 FALCON M.'99

Bases de Cil. ALMA METAL
incluidas en las líneas
PREMIUM y PREMIUM C/O RING



EQUIVALENTES

HONDA: NX 400 FALCON - XR 400 (TODOS LOS MODELOS)

CODIGO	UNIDAD	MATERIAL
20185 P	JUEGO COMPLETO	PREMIUM
20185 P/O	JUEGO COMPLETO	PREMIUM C/O RING
21185 P	CABEZA DE CILINDRO	PREMIUM
21185 P/O	CABEZA DE CILINDRO	PREMIUM C/O RING
02022 A/M	BASE DE CILINDRO	ALMA METAL
24476 M	TAPA DE CILINDRO	METAL
02024	ESCAPE (2 X JGO)	CHAPA
02026 P	EMBRAGUE	PREMIUM
06754 P	CARTER	PREMIUM
24503 P	BOMBA AGUA	PREMIUM
02028 P	ALTERNADOR	PREMIUM
24504 P	JUNTA TRIANGULO	PREMIUM
02027 M	TAPA VALVULAS	METAL
02025 P	TENSOR CADENA	PREMIUM
9-618	KIT O RING COMPLETO	NITRILO
8-618	KIT O RING CABEZA CIL.	NITRILO

20185 P - Juego completo

21185 P - Cabeza de Cilindro



24476 M



02022 A/M



02024



02024

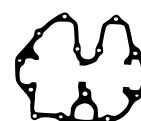

02027 M



02025 P



24503 P



24504 P

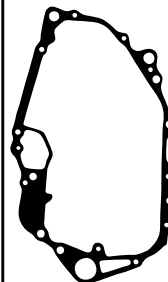

06754 M

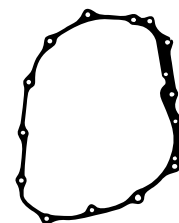

02026 P

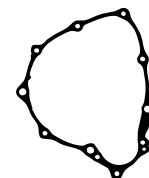

02028 P

9-618 - Kit O ring Completo

8-618 - Kit O ring Cabeza Cil.

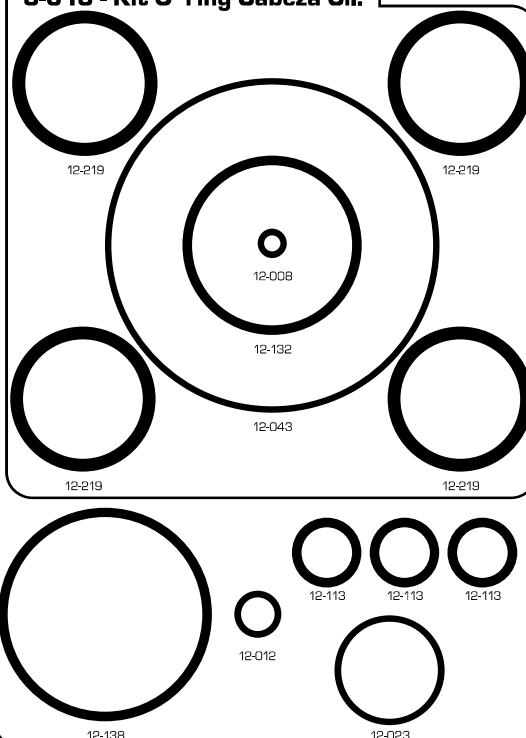

00174 P/O - HONDA CBR 600 F1-F2-F3

EQUIVALENTES

CODIGO	UNIDAD	MATERIAL
00174 P/O	JUEGO COMPLETO	PREMIUM C/O RING
02091 M	TAPA DE CILINDRO	METAL
02093 P	CARTER A	PREMIUM
23603 P	CARTER B	PREMIUM
02094 P	ALTERNADOR A	PREMIUM
23604 P	ALTERNADOR B	PREMIUM
02096 P	BOMBA AGUA	PREMIUM
25171 P	TAPA CAPTOR	PREMIUM
06759 P	ENCENDIDO	PREMIUM
06756 P	EMBRAGUE GDE.	PREMIUM
06760 P	EMBRAGUE CHICO	PREMIUM
12-626	KIT O'RING COMPLETO	NITRILO

00174 P/O - Juego Completo

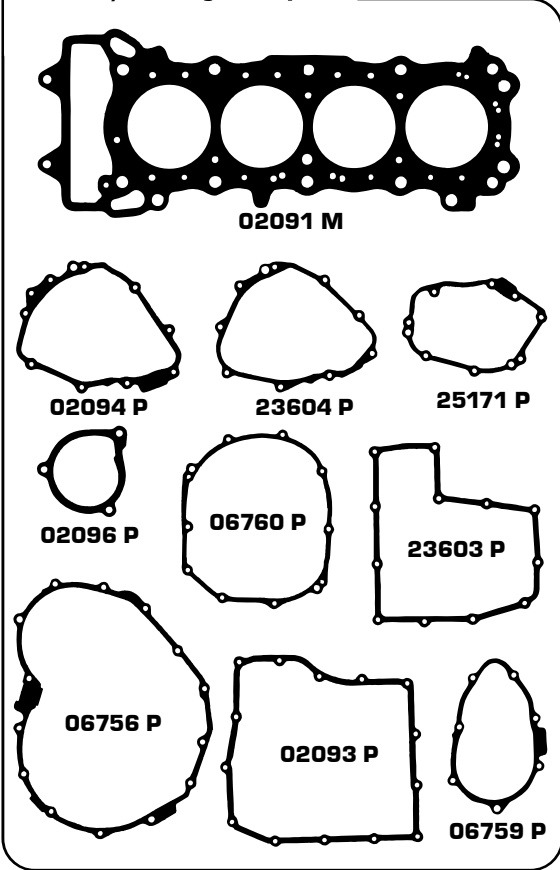

9-626 - Kit O´ring Completo

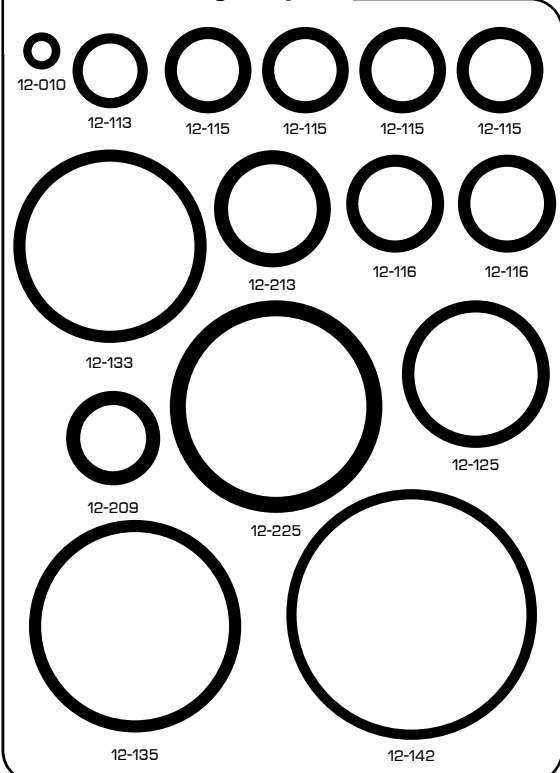

Bases de Cil. ALMA METAL
incluidas en las líneas
PREMIUM y PREMIUM C/O'RING



20377 P - JAWA 300 E (SIN BAL.)

EQUIVALENTES	
JAWA: 300 - 6 / 300 - 9	

CODIGO	UNIDAD	MATERIAL
20377 P	JUEGO COMPLETO	PREMIUM
20377 P/O	JUEGO COMPLETO	PREMIUM C/O'RING
21377 P	CABEZA DE CILINDRO	PREMIUM
21377 P/O	CABEZA DE CILINDRO	PREMIUM C/O'RING
25291 A/M	BASE DE CILINDRO	ALMA METAL
25201 M	TAPA DE CILINDRO	METAL
25292	ESCAPE (2 X JGO.)	CHAPA
25296 P	CARTER	PREMIUM
25293 P	EMBRAGUE	PREMIUM
25294 P	ALTERNADOR	PREMIUM
25295 P	C/TAPA ALTERNADOR	PREMIUM
9-646	KIT O'RING COMPLETO	NITRILO
8-646	KIT O'RING CABEZA CIL.	NITRILO

20377 P - Juego Completo

21377 P - Cabeza de Cilindro

25201 M 25291 A/M 25292

25292

25293 P 25294 P

25295 P 25296 P

9-646 - Kit O'ring Completo

8-646 - Kit O'ring Cabeza Cil.

12-012 12-012 12-012 12-012

12-113 12-113 12-017

12-120 12-120

12-113 12-209

12-121 12-123 12-028



Bases de Cil. ALMA METAL
incluidas en las líneas
PREMIUM y PREMIUM C/O RING

20378 P - JAWA 350 9 (SIN BAL.)



EQUIVALENTES	
JAWA: SPYDER 350 / RUTA 40 350 / DAYTONA 350	
BOBBER 350	

CODIGO	UNIDAD	MATERIAL
20378 P	JUEGO COMPLETO	PREMIUM
20378 P/O	JUEGO COMPLETO	PREMIUM C/O RING
21378 P	CABEZA DE CILINDRO	PREMIUM
21378 P/O	CABEZA DE CILINDRO	PREMIUM C/O RING
25297 A/M	BASE DE CILINDRO	ALMA METAL
25201 M	TAPA DE CILINDRO	METAL
25298	ESCAPE (2 X JGO.)	CHAPA
25302 P	CARTER	PREMIUM
25299 P	EMBRAGUE	PREMIUM
25300 P	ALTERNADOR	PREMIUM
25301 P	C/TAPA ALTERNADOR	PREMIUM
9-646	KIT O RING COMPLETO	NITRILO
8-646	KIT O RING CABEZA CIL.	NITRILO

20378 P - Juego Completo

21378 P - Cabeza de Cilindro

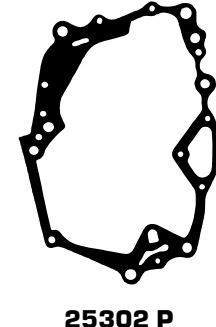
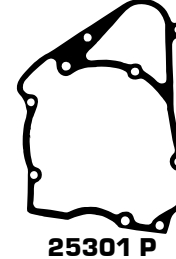
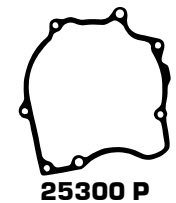
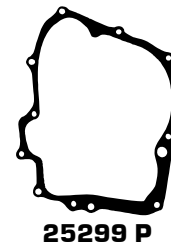
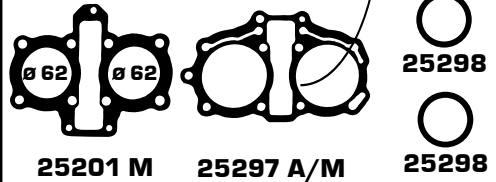

9-646 - Kit O ring Completo

8-646 - Kit O ring Cabeza Cil.

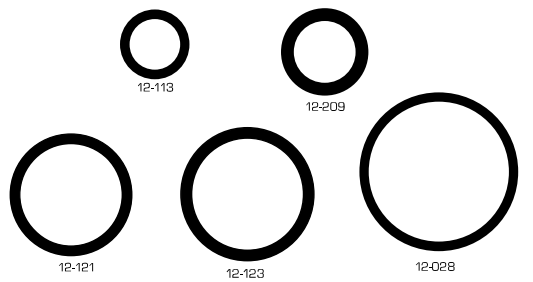
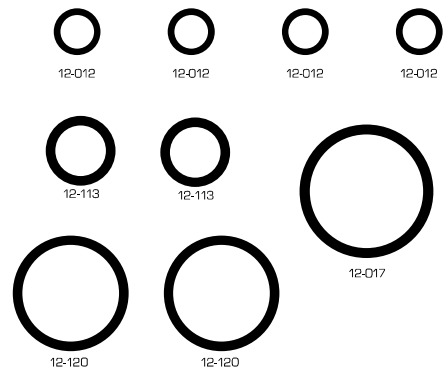

20388 P - JAWA 350 9 (CON BAL.)

Bases de Cil. ALMA METAL
incluidas en las líneas
PREMIUM y PREMIUM C/O' RING



EQUIVALENTES

JAWA: SPYDER 350 C/BAL. / RUTA 40 350 C/BAL.
 DAYTONA 350 C/BAL./ BOBBER 350 C/BAL.
ZANELLA: RX 350 NAKED / RZ 350 35R / CHOPPER 350

CODIGO	UNIDAD	MATERIAL
20388 P	JUEGO COMPLETO	PREMIUM
20388 P/O	JUEGO COMPLETO	PREMIUM C/O'RING
21388 P	CABEZA DE CILINDRO	PREMIUM
21388 P/O	CABEZA DE CILINDRO	PREMIUM C/O'RING
25304 A/M	BASE DE CILINDRO	ALMA METAL
25303 M	TAPA DE CILINDRO	METAL
25305	ESCAPE (2 X JGO.)	CHAPA
25309 P	CARTER	PREMIUM
25306 P	EMBRAGUE	PREMIUM
25207 P	ALTERNADOR	PREMIUM
25310 P	TENSOR CADENA	PREMIUM
25308	C/TAPA ALTERNADOR	PREMIUM
9-646	KIT O'RING COMPLETO	NITRILO
8-646	KIT O'RING CABEZA CIL.	NITRILO

20388 P - Juego Completo

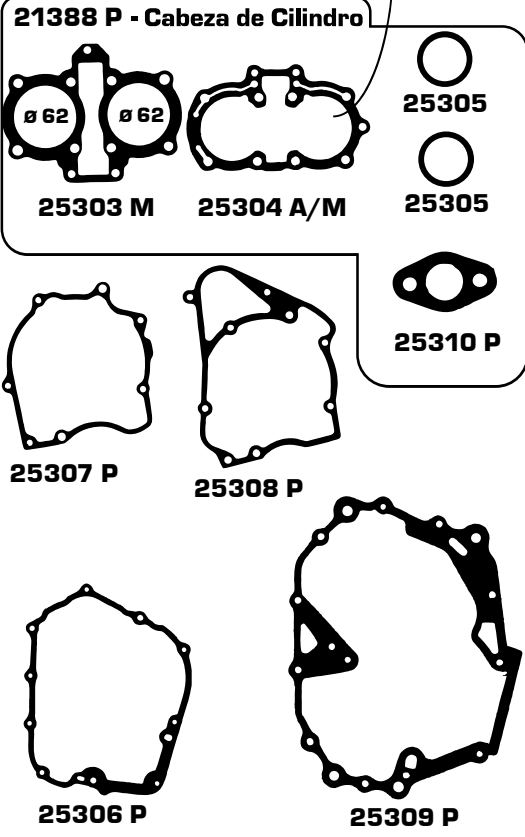

9-646 - Kit O´ring Completo

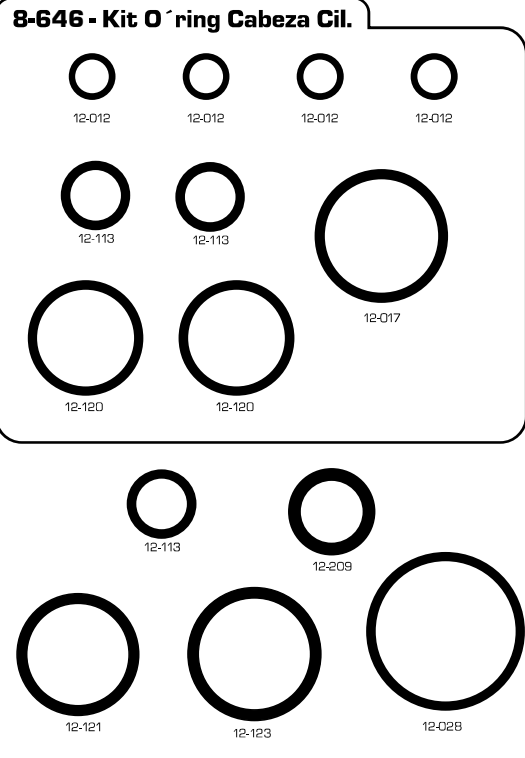



Motos y Cuatriciclos

20290 P - KELLER 260 STRATUS

Bases de Cil. ALMA METAL
incluidas en las líneas
PREMIUM y PREMIUM C/O'RING



EQUIVALENTES	
KELLER:	QUASAR 260 - R 260 (HASTA M.2013)
MOTOMEL:	VOLKANO 250 (CAD.)

CODIGO	UNIDAD	MATERIAL
20290 P	JUEGO COMPLETO	PREMIUM
20290 P/O	JUEGO COMPLETO	PREMIUM C/O'RING
21290 P	CABEZA DE CILINDRO	PREMIUM
21290 P/O	CABEZA DE CILINDRO	PREMIUM C/O'RING
23412 A/M	BASE DE CILINDRO	ALMA METAL
24477 M	TAPA DE CILINDRO	METAL
24477 A	TAPA DE CILINDRO	MFT
01782	ESCAPE	CHAPA
02025 P	TENSOR CADENA	PREMIUM
08867 P	EMBRAGUE	PREMIUM
25008 P	CARTER	PREMIUM
01332 P	ENCENDIDO IZQ.	PREMIUM
01786 P	ARBOL DE LEVAS	PREMIUM
06696 P	CENTRIFUGO ACEITE	PREMIUM
9-643	KIT O'RING COMPLETO	NITRILO
8-643	KIT O'RING CABEZA CIL.	NITRILO

20290 P - Juego completo

21290 P - Cabeza de Cilindro

24477 M 23412 A/M 01782
 02025 P

01332 P 01786 P 06696 P

08867 P 25008 P

9-643 - Kit O'ring Completo

8-643 - Kit O'ring Cabeza Cil.

12-218 12-217 12-217
 12-150 12-122 12-011 12-011

12-209 12-209
 12-230 12-121

12-010 12-011 12-110 12-110 12-112

20142 P - KELLER 260 RACING K2/NAKED (BAL.)

EQUIVALENTES	

CODIGO	UNIDAD	MATERIAL
20142 P	JUEGO COMPLETO	PREMIUM
21142 P	CABEZA DE CILINDRO	PREMIUM
24102 A/M	BASE DE CILINDRO	ALMA METAL
24103 A	TAPA DE CILINDRO	MFT
24104	ESCAPE	CHAPA
24105	ADMISION O'RING	NITRILO
24109 P	TENSOR CADENA	PREMIUM
24106 P	EMBRAGUE	PREMIUM
24107 P	CARTER	PREMIUM
24108 P	ENCENDIDO IZQ.	PREMIUM

20136 P - Juego Completo

21136 P - Cabeza de Cilindro

Bases de Cil. ALMA METAL
incluidas en las líneas
PREMIUM y **PREMIUM C/O'RING**

24103 A

 24102 A/M

 24104

 24105

 24109 P

24108 P

24106 P

24107 P

20498 P - KTM DUKE 390

Bases de Cil. ALMA METAL
incluidas en las líneas
PREMIUM y PREMIUM C/O RING

EQUIVALENTES

CODIGO	UNIDAD	MATERIAL
20498 P	JUEGO COMPLETO	PREMIUM
21498 P	CABEZA DE CILINDRO	PREMIUM
25460 A/M	BASE DE CILINDRO	ALMA METAL
25461 M	TAPA DE CILINDRO	METAL
25194	ESCAPE	CHAPA
25462 P	EMBRAGUE	PREMIUM
25463 P	ALTERNADOR	PREMIUM
25464 P	TENSOR CADENA	PREMIUM
12-7595	BOMBA DE AGUA	NITRILLO

20498 P - Juego Completo

21498 P - Cabeza de Cilindro

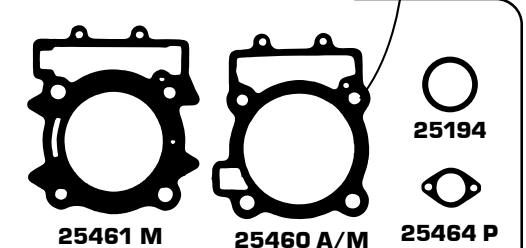

Metal / Material Premium

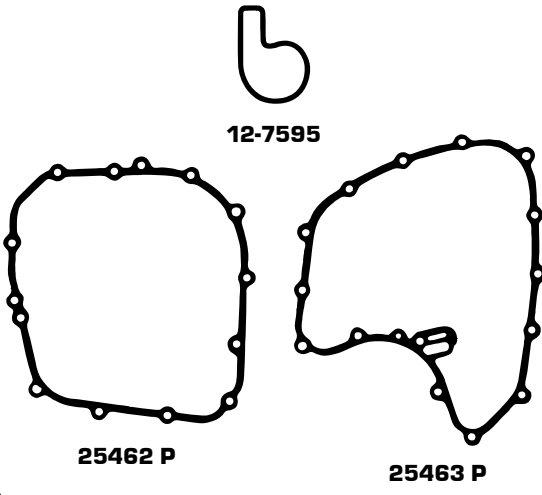

12-7595
25462 P 25463 P

Bases de Cil. ALMA METAL
incluidas en las líneas
PREMIUM y PREMIUM C/O'RING



00227 P - MONDIAL MD/HD 125

EQUIVALENTES	
MONDIAL:	RD 125 (VAR.)
CERRO:	STREET 125
KONISA:	LF 125

CODIGO	UNIDAD	MATERIAL
00227 P	JUEGO COMPLETO	PREMIUM C/T. VALV.
00227 P/O	JUEGO COMPLETO	PREM. C/O'RING Y T/V
00588 P	CABEZA DE CILINDRO	PREMIUM
00588 P/O	CABEZA DE CILINDRO	PREM. C/O'RING Y T/V
02430 A/M	BASE DE CILINDRO	ALMA METAL
02431 A	TAPA DE CILINDRO	MFT
02432	ESCAPE	CHAPA
02433 P	ADMISION (2 X JGO)	PREMIUM
02434 P	EMBRAGUE	PREMIUM
03437 P	CARTER	PREMIUM
02435	BOMBA ACEITE	ADAMITE
02438 P	ENCENDIDO IZQ.	PREMIUM
02436 P	T/CENT. ACEITE	PREMIUM
12-7545	TAPA DE VÁLVULAS	NITRILO
9-641	KIT O'RING COMPLETO	NITRILO
8-641	KIT O'RING CABEZA CIL.	NITRILO

00227 P - Juego completo

00588 P - Cabeza de Cilindro

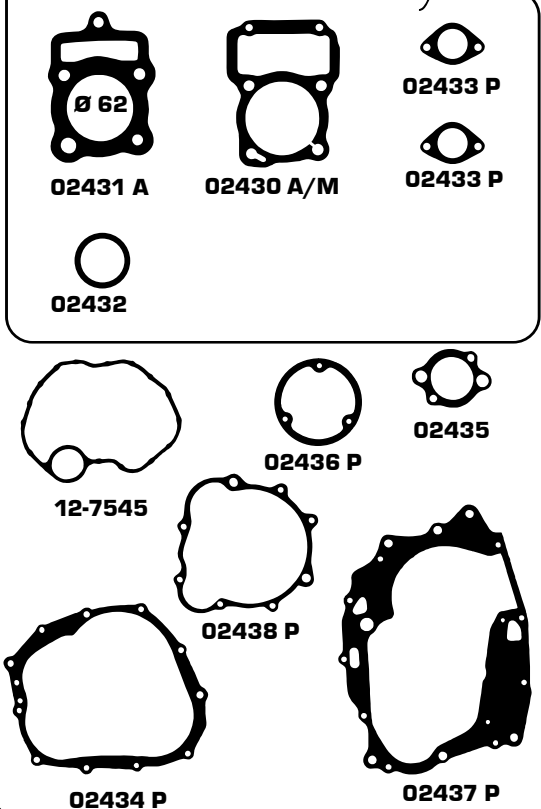

Ø 62

Metal

Material Premium

9-641 - Kit O´ring Completo

8-641 - Kit O´ring Cabeza Cil.

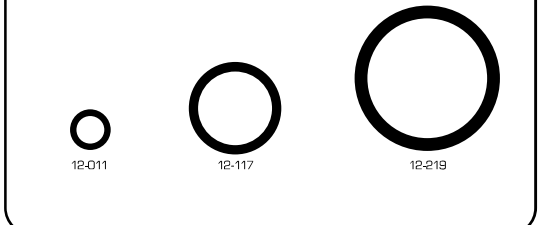
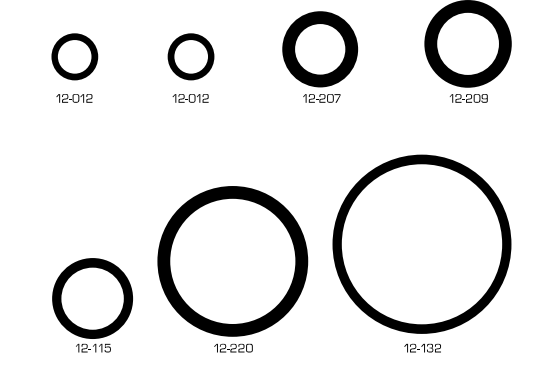
20460 P - MONDIAL EX 150 K

Bases de Cil. ALMA METAL incluidas en las líneas PREMIUM y PREMIUM C/O RING

EQUIVALENTES	
ZANELLA: PATAGONIA EAGLE 150 BLACK METAL	

CODIGO	UNIDAD	MATERIAL
20460 P	JUEGO COMPLETO	PREMIUM
21460 P	CABEZA DE CILINDRO	PREMIUM
25408 A/M	BASE DE CILINDRO	ALMA METAL
25409 M	TAPA DE CILINDRO	METAL
25410	ESCAPE	CHAPA
25411 P	TENSOR CADENA	PREMIUM
25412 P	T/CENT. ACEITE	PREMIUM
25413 P	T/ARBOL DE LEVAS	PREMIUM
25414 P	EMBRAGUE	PREMIUM
25415 P	ENCENDIDO	PREMIUM
25416 P	CARTER	PREMIUM
25417	BOMBA ACEITE	ADAMITE

20460 P - Juego Completo

21460 P - Cabeza de Cilindro

25409 M 25408 A/M 25410

25411 P

25412 P 25413 P

25415 P

25417

25416 P 25414 P

20122 P - MOTOMEL 125 X3M

Bases de Cil. ALMA METAL
incluidas en las líneas
PREMIUM y PREMIUM C/O RING



EQUIVALENTES	
GILERA:	VC 125 F/D
MAVERICK:	CITY 125 (VAR.) / MOTOMEL: CG 125 - TOP 125 (VAR.)
SUMO:	CG 125 (VAR.)
ZANELLA:	SAPUCAI 125 4T. - RX 125 M.NVO.

CODIGO	UNIDAD	MATERIAL
20122 P	JUEGO COMPLETO	PREMIUM C/T. VALV.
20122 P/O	JUEGO COMPLETO	PREM. C/O RING Y T/V
21122 P	CABEZA DE CILINDRO	PREMIUM
21122 P/O	CABEZA DE CILINDRO	PREM. C/O RING Y T/V
24235 A/M	BASE DE CILINDRO	ALMA METAL
24236 A	TAPA DE CILINDRO	MFT
24237	ESCAPE	CHAPA
24238 P	ADMISION (2 X JGO)	PREMIUM
24239 P	EMBRAGUE	PREMIUM
24240 P	CARTER	PREMIUM
24241	BOMBA ACEITE	ADAMITE
24242 P	ENCENDIDO IZQ.	PREMIUM
24243 P	T/CENT. ACEITE	PREMIUM
12-7545	TAPA DE VÁLVULAS	NITRILO
9-642	KIT O RING COMPLETO	NITRILO
8-642	KIT O RING CABEZA CIL.	NITRILO

20122 P - Juego completo

21122 P - Cabeza de Cilindro



24236 A



24235 A/M



24238 P



24238 P



24237



12-7545



24243 P



24241

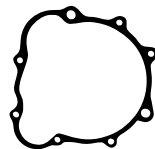

24242 P

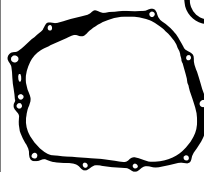

24239 P



24240 P

9-642 - Kit O ring Completo

8-642 - Kit O ring Cabeza Cil.



12-012



12-012



12-013



12-114

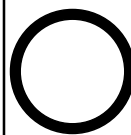

12-122



12-115



12-116

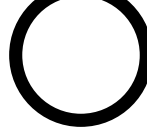

12-218



12-112



12-112



12-207



12-209

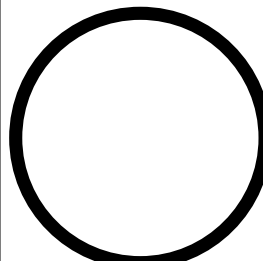

12-230

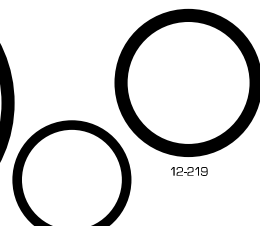

12-219



12-121

20104 P - MOTOMEL SKUA 150 (VAR.)

EQUIVALENTES

GILERA: GA 150 / CERRO: PRINCE 150 (VAR.) - CE 150 (VAR.)

IMSA: ROAD 150 / MONDIAL: RD 150 (VAR.) TD 150 - HD 150

MOTOMEL: HD 150 (VAR.)

ZANELLA: HJ 150

CODIGO	UNIDAD	MATERIAL
20104 P	JUEGO COMPLETO	PREMIUM C/T. VALV.
20104 P/O	JUEGO COMPLETO	PREM. C/O'RING Y T/V
21105 P	CABEZA DE CILINDRO	PREMIUM
21105 P/O	CABEZA DE CILINDRO	PREM. C/O'RING Y T/V
23822 A/M	BASE DE CILINDRO	ALMA METAL
23823 A	TAPA DE CILINDRO	MFT
23823 M	TAPA DE CILINDRO	METAL
23824	ESCAPE	CHAPA
23825 P	ADMISION (2 X JGO)	PREMIUM
23826 P	EMBRAGUE	PREMIUM
23827 P	CARTER	PREMIUM
23828	BOMBA ACEITE	ADAMITE
23830 P	ENCENDIDO IZQ.	PREMIUM
23832	T/CENT. ACEITE	PREMIUM
12-7545	TAPA DE VÁLVULAS	NITRILO
9-642	KIT O'RING COMPLETO	NITRILO
8-642	KIT O'RING CABEZA CIL.	NITRILO

Bases de Cil. ALMA METAL
incluidas en las líneas
PREMIUM y PREMIUM C/O'RING



20104 P - Juego Completo

21105 P - Cabeza de Cilindro



23823 A



23822 A/M



23825 P



23825 P



23824

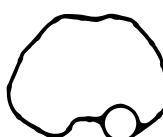

12-7545



23832 P



23828

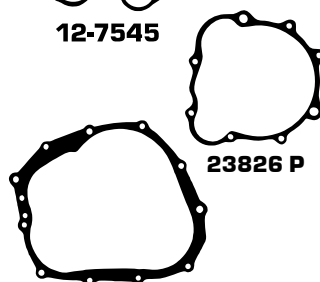

23826 P



23827 P

23830 P

9-642 - Kit O'ring Completo

8-642 - Kit O'ring Cabeza Cil.



12-012



12-012



12-013



12-114

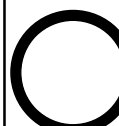

12-122



12-115



12-116

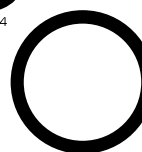

12-218



12-112



12-112



12-207



12-209

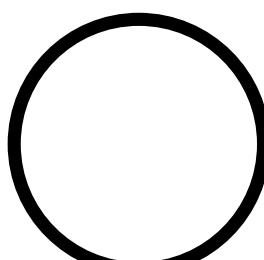

12-230



12-121



12-219



Bases de Cil. ALMA METAL
incluidas en las lineas PREMIUM



06193 P - MOTOMEL VX 150

EQUIVALENTES

BETA: ARROW R8 150 - GRINDER 150 - TEMPO DELUXE 150
BRAVA: WINSTAR 150 / **GUERRERO:** KRYON 150 / **CERRO:** R9 125
MONDIAL: HD 150 / **MOTOMEL:** SL 125 / **KELLER:** E-XTREME 150 -
CONQUISTAR 150 / VESPA: PHANTOM 150 / **ZANELLA:** ZSC 125

CODIGO	UNIDAD	MATERIAL
06193 P	JUEGO COMPLETO	PREMIUM C/T. VALV.
06470 P	CABEZA DE CILINDRO	PREMIUM C/T. VALV.
08884 A/M	BASE DE CILINDRO	ALMA METAL
08885 M	TAPA DE CILINDRO	METAL
08885 A	TAPA DE CILINDRO	MFT
08886	ESCAPE	CHAPA
08887 P	ADMISION	PREMIUM
08888 P	CARTER	PREMIUM
08915	TAPA DE VALVULAS	NITRILO
08889 P	CADENA	PREMIUM
08890 P	TENSOR CADENA	PREMIUM
23680 P	TRANSMISION	PREMIUM
08891 P	CARTER LATERAL	PREMIUM

06193 P - Juego Completo

06470 P - Cabeza de Cilindro

08885 M **08884 A/M** **08887 P**

08890 P

08915 **08886**

23680 P **08891 P** **08888 P**

08889 P



06200 P - MOTOMEL 200 DAKAR (CADENERO)

Bases de Cil. ALMA METAL
incluidas en las líneas
PREMIUM y PREMIUM C/O'RING



EQUIVALENTES
GUERRERO: TUNDRA 200 (CAD.)
CERRO: COLT 200 - 250 (CUATRICICLO)
MOTOMEL: SR 200

CODIGO	UNIDAD	MATERIAL
06200 P	JUEGO COMPLETO	PREMIUM
06200 P/O	JUEGO COMPLETO	PREMIUM C/O'RING
06479 P	CABEZA DE CILINDRO	PREMIUM
06479 P/O	CABEZA DE CILINDRO	PREMIUM C/O'RING
08929 A/M	BASE DE CILINDRO	ALMA METAL
08928 A	TAPA DE CILINDRO	MFT
23303	ESCAPE	CHAPA
23304 P	TENSOR CADENA	PREMIUM
23305 P	EMBRAGUE	PREMIUM
23306 P	CARTER	PREMIUM
23308 P	ENCENDIDO CHICO	PREMIUM
23309 P	ENCENDIDO IZQ.	PREMIUM
23310 P	ARBOL DE LEVAS	PREMIUM
23311 P	CENTRIFUGO ACEITE	PREMIUM
23307	BOMBA ACEITE	ADAMITE
9-643	KIT O'RING COMPLETO	NITRILO
8-643	KIT O'RING CABEZA CIL.	NITRILO

06200 P - Juego completo

06479 P - Cabeza de Cilindro

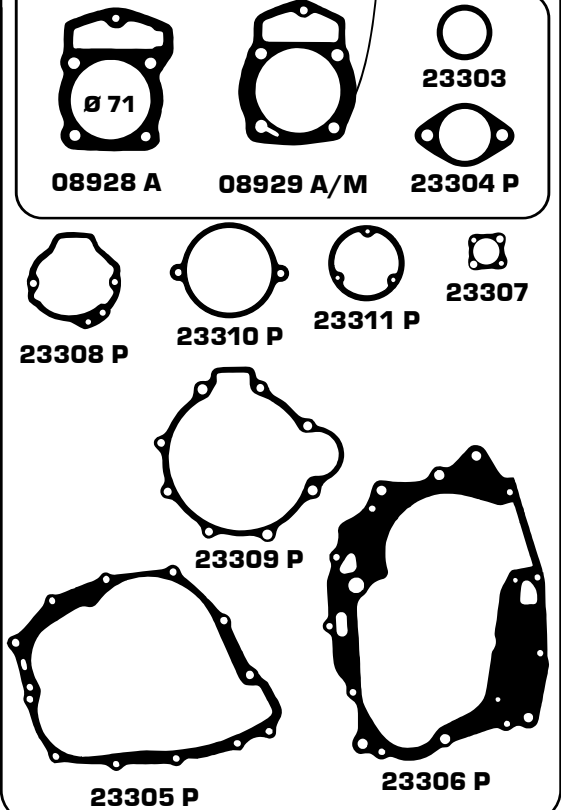

9-643 - Kit O'ring Completo

8-643 - Kit O'ring Cabeza Cil.

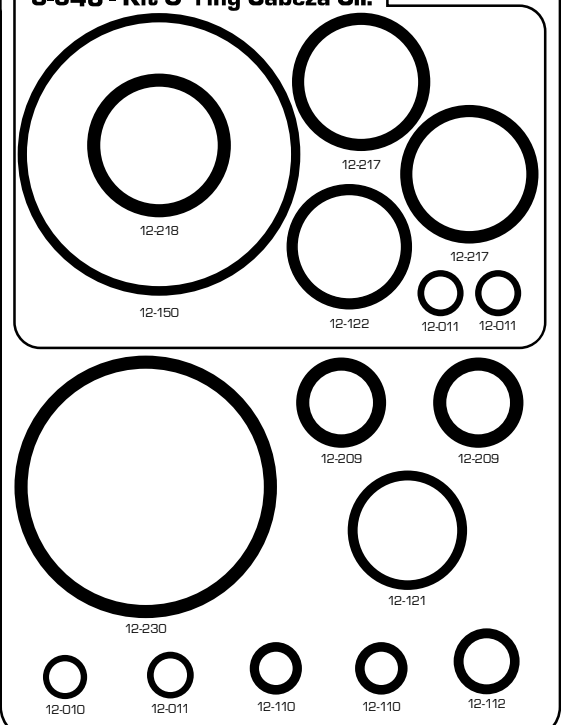

Bases de Cil. ALMA METAL
incluidas en las líneas
PREMIUM y PREMIUM C/O RING



06177 P - MOTOMEL DAKAR 200 (VARILLERO)

EQUIVALENTES

APPIA: HARDWING 200 - SL 200
CERRO: SCRATCH 200 - COLT 200
GILERA: 200 (VAR.) / YL 200 (CROPERA)
GUERRERO: TUNDRA 200
HONDA: CG 200 / KELLER: MIRACLE 200
MONDIAL: TD 200 - RD 200
MOTOMEL: CUSTOM 200 (VAR.) - SR 200
SUMO: SL 200
ZANELLA: Z TT 200 - RX 200

CODIGO	UNIDAD	MATERIAL
06177 P	JUEGO COMPLETO	PREMIUM C/T. VALV.
06177 P/O	JUEGO COMPLETO	PREM. C/O'RING Y T/V
06453 P	CABEZA DE CILINDRO	PREMIUM
06453 P/O	CABEZA DE CILINDRO	PREM. C/O'RING Y T/V
08882 A/M	BASE DE CILINDRO	ALMA METAL
08883 A	TAPA DE CILINDRO	MFT
23015	ESCAPE	CHAPA
23016 P	TENSOR CADENA	PREMIUM
23017 P	EMBRAGUE	PREMIUM
23018 P	CARTER	PREMIUM
23019	BOMBA ACEITE	ADAMITE
23021 P	ENCENDIDO IZQ.	PREMIUM
23023 P	T/CENT. ACEITE	PREMIUM
12-7545	TAPA DE VÁLVULAS	NITRILO
9-642	KIT O'RING COMPLETO	NITRILO
8-642	KIT O'RING CABEZA CIL.	NITRILO

06177 P - Juego Completo

06453 P - Cabeza de Cilindro



08883 A



08882 A/M



23015



23016 P

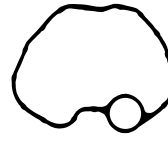

12-7545



23023 P



23019

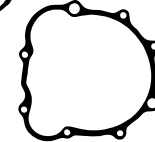

23021 P

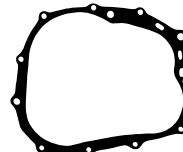

23017 P



23018 P

9-642 - Kit O´ring Completo

8-642 - Kit O´ring Cabeza Cil.

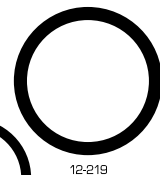
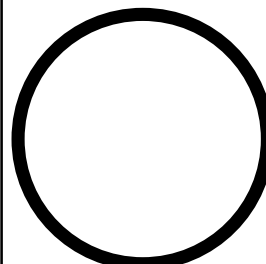
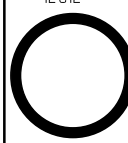

20345 P - MOTOMEL 200 SIRIUS

Bases de Cil. ALMA METAL
incluidas en las líneas
PREMIUM y PREMIUM C/O'RING



EQUIVALENTES

CODIGO	UNIDAD	MATERIAL
20345 P	JUEGO COMPLETO	PREMIUM C/T. VALV.
20345 P/O	JUEGO COMPLETO	PREM. C/O'RING Y T/V
21345 P	CABEZA DE CILINDRO	PREMIUM
21345 P/O	CABEZA DE CILINDRO	PREM. C/O'RING Y T/V
08882 A/M	BASE DE CILINDRO	ALMA METAL
08883 A	TAPA DE CILINDRO	MFT
08883 M	TAPA DE CILINDRO	METAL
00692	ESCAPE	CHAPA
06693 P	ADMISION (2 X JGO)	PREMIUM
08867 P	EMBRAGUE	PREMIUM
25159 P	CARTER	PREMIUM
06697	BOMBA ACEITE	ADAMITE
08868 P	ENCENDIDO IZQ.	PREMIUM
06696 P	CENTRIFUGO ACEITE	PREMIUM
12-7545	TAPA VÁLVULAS	NITRILO
9-642	KIT O'RING COMPLETO	NITRILO
8-642	KIT O'RING CABEZA CIL.	NITRILO

20345 P - Juego completo

21345 P - Cabeza de Cilindro

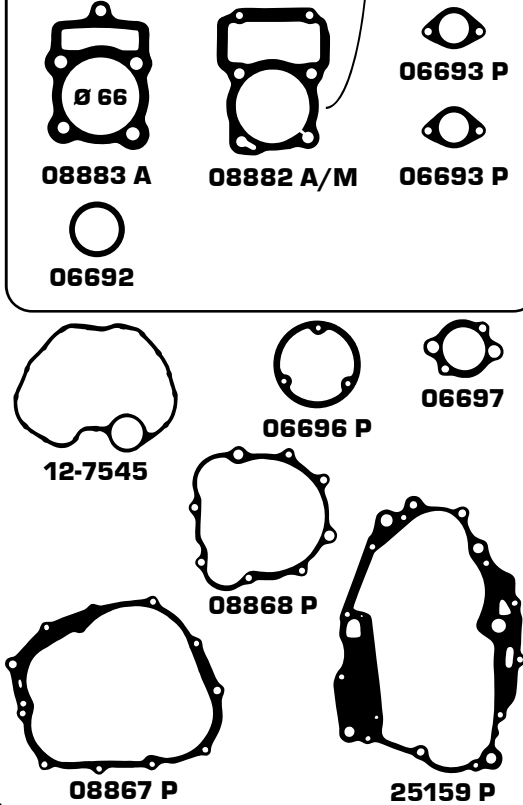

9-642 - Kit O'ring Completo

8-642 - Kit O'ring Cabeza Cil.

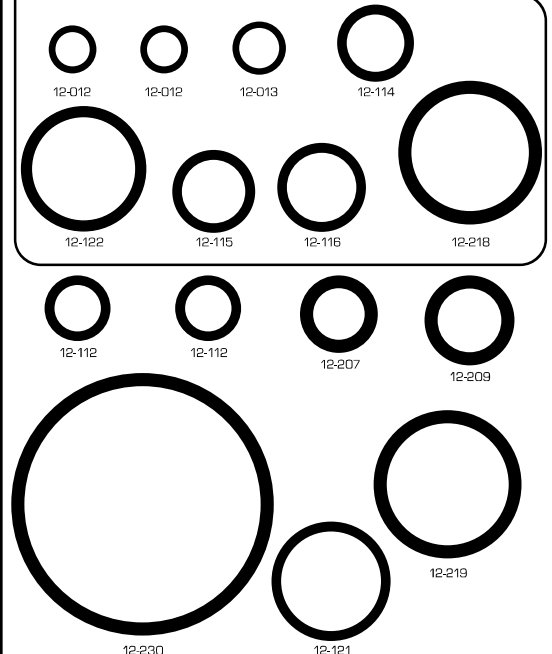

20105 P - MOTOMEL SKUA 200 MOTARD (VAR. BAL. GDE.)

EQUIVALENTES

BRAVA: 200 (VAR.BAL.) / CORVEN: MOTARD 200 (VAR. BAL.)
TRIAx 200 R3 (BAL.) - TRIAX 250 R3 (BAL.)
GILERA: VCR 200 (VAR. BAL.)/ MOTOMEL: KS 200 PISTERA (VAR.BAL.)
SKUA 200 MOTARD M. 2010-SKUA 250 (VAR. BAL.)
XMM 250 (VAR.BAL.)-XPLORA 250 (VAR. BAL.) ZANELLA: ZR 250 LT

CODIGO	UNIDAD	MATERIAL
20105 P	JUEGO COMPLETO	PREMIUM C/T. VALV.
20105 P/O	JUEGO COMPLETO	PREM. C/O'RING Y T/V
21106 P	CABEZA DE CILINDRO	PREMIUM
21106 P/O	CABEZA DE CILINDRO	PREM. C/O'RING Y T/V
23833 A/M	BASE DE CILINDRO	ALMA METAL
23434 A	TAPA DE CILINDRO	MFT
23835	ESCAPE	CHAPA
23836 P	ADMISION (2 X JGO)	PREMIUM
23837 P	EMBRAGUE	PREMIUM
23838 P	CARTER	PREMIUM
23839 P	BOMBA ACEITE	PREMIUM
23841 P	ENCENDIDO IZQ.	PREMIUM
23919 P	CENTRIFUGO ACEITE	PREMIUM
12-7545	TAPA VÁLVULAS	NITRILO
9-642	KIT O'RING COMPLETO	NITRILO
8-642	KIT O'RING CABEZA CIL.	NITRILO

20105 P - Juego completo

21106 P - Cabeza de Cilindro



23834 A



23833 A/M

Bases de Cil. ALMA METAL
incluidas en las líneas
PREMIUM y PREMIUM C/O' RING

Metal
Material Premium



23835



23836 P



23836 P



12-7545



23919 P



23839

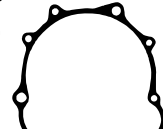

23841 P

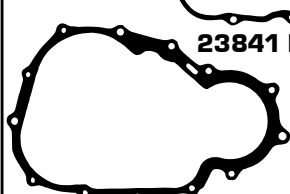

23837 P

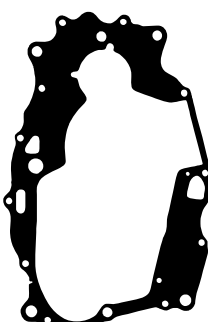

23838 P

9-642 - Kit O'ring Completo

8-642 - Kit O'ring Cabeza Cil.



12-012



12-012



12-013



12-114

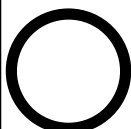

12-122



12-115



12-116



12-218



12-112



12-112



12-207



12-209

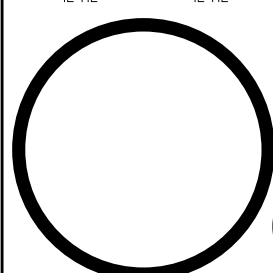

12-230



12-219

12-121



20296 P - MOTOMEL XMM 250 (CAD. BAL.)

Bases de Cil. ALMA METAL incluidas en las líneas PREMIUM y PREMIUM C/O RING



EQUIVALENTES	

CODIGO	UNIDAD	MATERIAL
20296 P	JUEGO COMPLETO	PREMIUM
20296 P/O	JUEGO COMPLETO	PREMIUM C/O RING
21296 P	CABEZA DE CILINDRO	PREMIUM
21296 P/O	CABEZA DE CILINDRO	PREMIUM C/O RING
24508 A/M	BASE DE CILINDRO	ALMA METAL
24509 M	TAPA DE CILINDRO	METAL
24509 A	TAPA DE CILINDRO	MFT
24510	ESCAPE	CHAPA
24511 P	ADMISION (2 X JGO)	PREMIUM
24512 P	EMBRAGUE	PREMIUM
24513 P	CARTER	PREMIUM
24514	BOMBA ACEITE	ADAMITE
24515 P	ENCENDIDO IZQ.	PREMIUM
24516 P	CENTRIFUGO ACEITE	PREMIUM
24517 P	ARBOL DE LEVAS	PREMIUM
02025 P	TENSOR CADENA	PREMIUM
9-643	KIT O RING COMPLETO	NITRILO
8-643	KIT O RING CABEZA CIL.	NITRILO

20296 P - Juego completo

21296 P - Cabeza de Cilindro

24509 M 24508 A/M 24511 P
 24510 02025 P

24517 P 24516 P 24514
 24512 P 24515 P 24513 P

9-643 - Kit O ring Completo

8-643 - Kit O ring Cabeza Cil.

12-218 12-217 12-217
 12-150 12-122 12-011 12-011
 12-209 12-209
 12-230 12-121
 12-010 12-011 12-110 12-110 12-112



Motos y Cuatriciclos

20119 P - MOTOMEL 250 XPLORA

Bases de Cil. ALMA METAL
incluidas en las líneas
PREMIUM y PREMIUM C/O RING

EQUIVALENTES	
ATV: WATER COOLER 200 / KELLER: QUAD RACE 250	
OKINOI: MOTARD 250 / MAVERICK: PANTHER 250 / MONDIAL: 256	
MOTOMEL: VOLKANO 250 (VAR.) / SCOUT: C MAX 250	
SUMO: RINO 250 / ZANELLA: FX SCORPION 250	

CODIGO	UNIDAD	MATERIAL
20119 P	JUEGO COMPLETO	PREMIUM C/T. VALV.
20119 P/O	JUEGO COMPLETO	PREM. C/O RING Y T/V
21120 P	CABEZA DE CILINDRO	PREMIUM
21120 P/O	CABEZA DE CILINDRO	PREM. C/O RING Y T/V
24264 A/M	BASE DE CILINDRO	ALMA METAL
24265 A	TAPA DE CILINDRO	MFT
24266	ESCAPE	CHAPA
24267 P	ADMISION (2 X JGO)	PREMIUM
24268 P	EMBRAGUE	PREMIUM
24269 P	CARTER	PREMIUM
24270	BOMBA ACEITE	ADAMITE
24271 P	ENCENDIDO IZQ.	PREMIUM
24272 P	CENTRIFUGO ACEITE	PREMIUM
9-642	KIT O RING COMPLETO	NITRILO
8-642	KIT O RING CABEZA CIL.	NITRILO

20119 P - Juego completo

21120 P - Cabeza de Cilindro

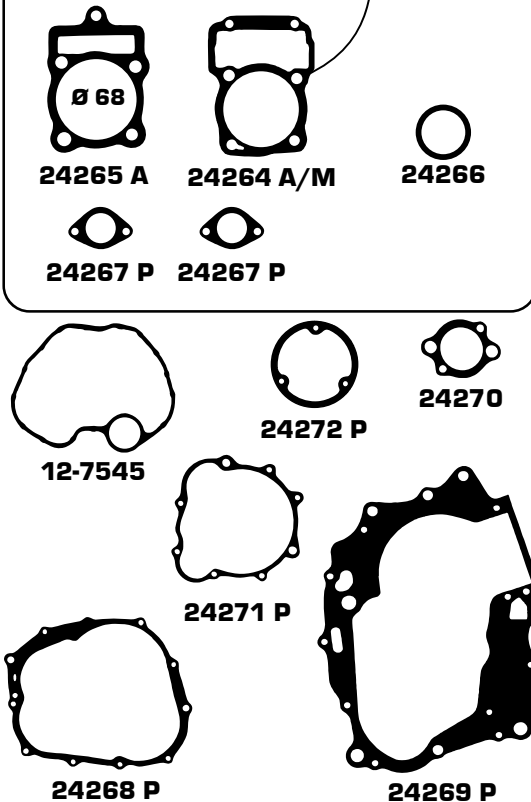

9-642 - Kit O ring Completo

8-642 - Kit O ring Cabeza Cil.

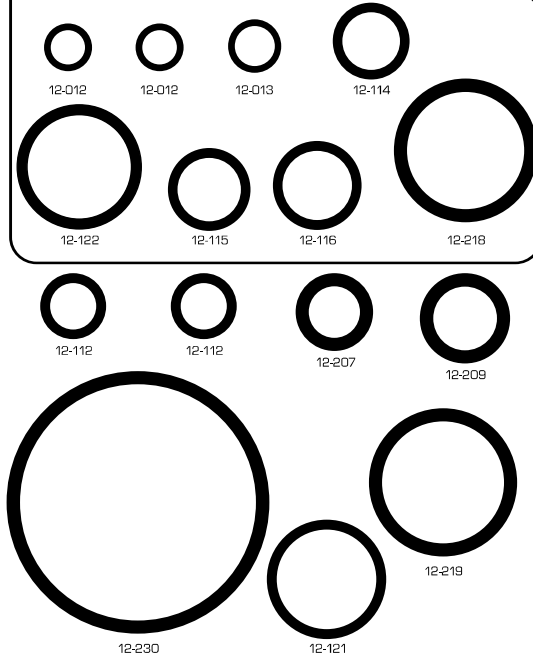

20099 P - PANTHER 250

Bases de Cil. ALMA METAL
incluidas en las líneas
PREMIUM y PREMIUM C/O RING

EQUIVALENTES

CODIGO	UNIDAD	MATERIAL
20099 P	JUEGO COMPLETO	PREMIUM
21101 P	CABEZA DE CILINDRO	PREMIUM
25432 A/M	BASE DE CILINDRO	ALMA METAL
25433 M	TAPA DE CILINDRO	METAL
25434	ESCAPE	CHAPA
25435 P	EMBRAGUE	PREMIUM
25436 P	CARTER	PREMIUM
25437 P	ENCENDIDO	PREMIUM
25438 P	CENTRIFUGO ACEITE	PREMIUM
25439 P	T/ARBOL DE LEVAS	PREMIUM

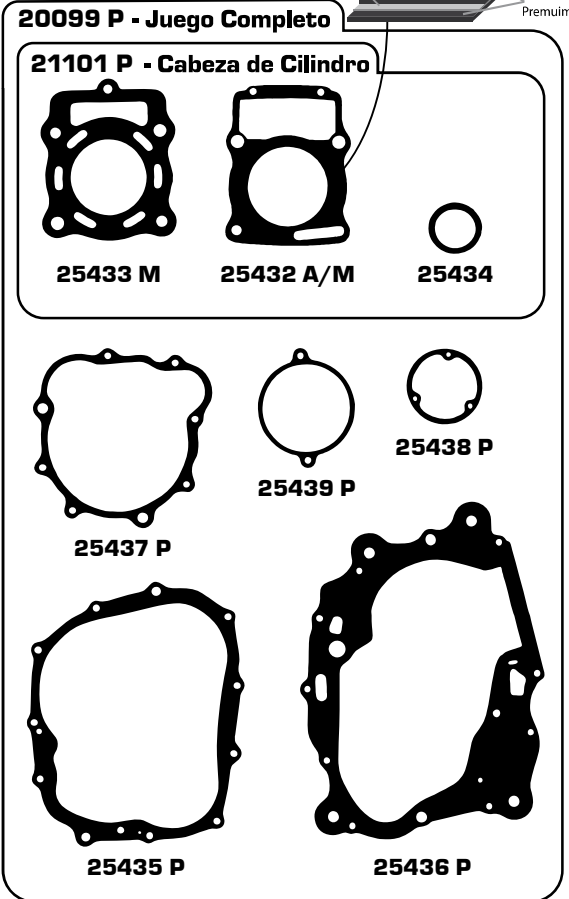



20128 P - PITBULL 200

Bases de Cil. ALMA METAL
incluidas en las líneas
PREMIUM y PREMIUM C/O RING



EQUIVALENTES
GAMMA: 200 ADVENTURE

CODIGO	UNIDAD	MATERIAL
20128 P	JUEGO COMPLETO	PREMIUM
21128 P	CABEZA DE CILINDRO	PREMIUM
24390 A/M	BASE DE CILINDRO	ALMA METAL
24391 M	TAPA DE CILINDRO	METAL
24391 A	TAPA DE CILINDRO	MFT
24392	ESCAPE	CHAPA
24393 P	EMBRAGUE	PREMIUM
24394 P	CARTER	PREMIUM
24395 P	ENCENDIDO	PREMIUM

20128 P - Juego Completo

21128 P - Cabeza de Cilindro

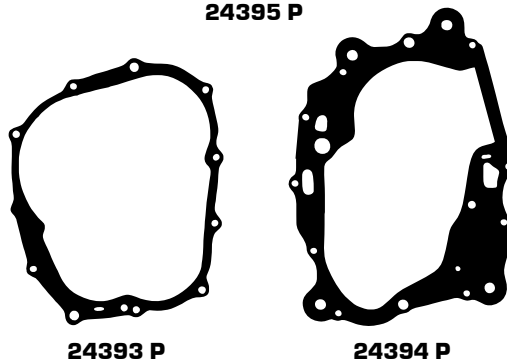
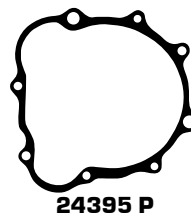
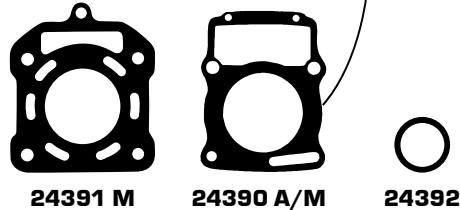



Motos y Cuatriciclos

00341 P - SUZUKI AX 100

EQUIVALENTES
AX SAP: 100 / BAJAJ: 100 2T. / DA-DALT: 100 2T. / GILERA: AX 100
GUERRERO: MB 100 / MONDIAL: 100 2T. - AX 115
MOTOMEL: AX 100 / Q. AX: 100 CHINA / Q. JIAM: 100
SUZUKI: AX 115

CODIGO	UNIDAD	MATERIAL
00341 P	JUEGO COMPLETO	PREMIUM
00341 P/O	JUEGO COMPLETO	PREMIUM C/O'RING
00769 P	CABEZA DE CILINDRO	PREMIUM
03082 P	BASE DE CILINDRO	PREMIUM
03083 M	TAPA DE CILINDRO	METAL
03084	ESCAPE	CHAPA
03085 P	EMBRAGUE	PREMIUM
03086 P	CARTER	PREMIUM
03098	CUBA CARBURADOR	ADAMITE
03087 P	BOMBA ACEITE	PREMIUM
9-628	KIT O'RING COMPLETO	NITRILO

00341 P - Juego completo

00769 P - Cabeza de Cilindro

03083 M (Cylinder head cap) with $\varnothing 56$ marking.
 03082 P (Cylinder head base).
 03084 (Escape ring).
 03087 P (Oil pump).
 03085 P (Clutch cover).
 03086 P (Oil pan).
 08098 P (Small square component).

9-628 - Kit O ring Completo

12-009 (Small O-ring).
 12-011 (Small O-ring).
 12-014 (Medium O-ring).
 12-014 (Medium O-ring).
 12-05 (Large O-ring).

20097 P - SUZUKI EN 125

EQUIVALENTES

KEEWAY: RKS 150

CODIGO	UNIDAD	MATERIAL
20097 P	JUEGO COMPLETO	PREMIUM
20097 P/O	JUEGO COMPLETO	PREMIUM C/O'RING
21099 P	CABEZA DE CILINDRO	PREMIUM
23770 A/M	BASE DE CILINDRO	ALMA METAL
23771 M	TAPA DE CILINDRO	METAL
23772	ESCAPE	CHAPA
23773 P	EMBRAGUE	PREMIUM
23774 P	ALTERNADOR	PREMIUM
24245 P	TENSOR DIST.	PREMIUM
9-633	KIT O'RING JUEGO COMP.	NITRIL

Bases de Cil. ALMA METAL
incluidas en las líneas
PREMIUM y PREMIUM C/O' RING



20097 P - Juego completo

21099 P - Cabeza de Cilindro



23771 M

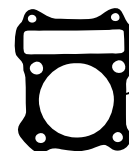

23770 A/M



23772



23775 P

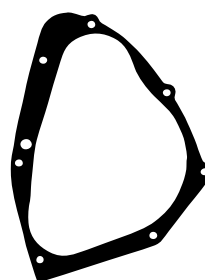

23774 P

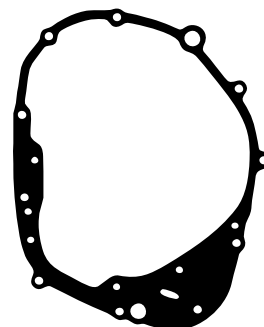

23773 P

9-633 - Kit O'ring Completo

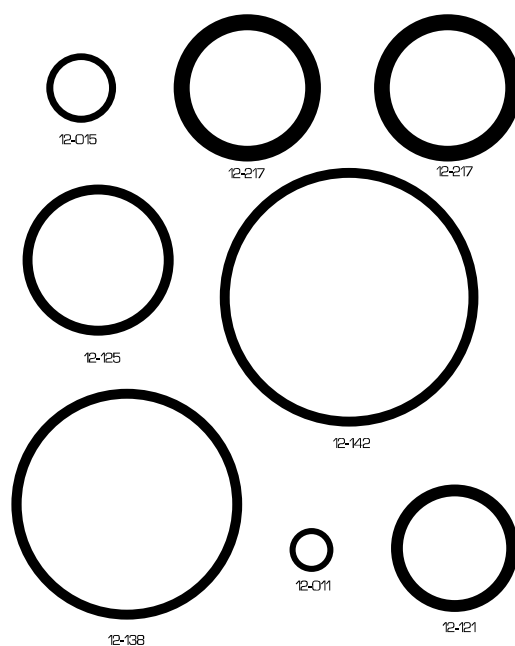



Motos y Cuatriciclos

00421 P - YAMAHA CRYPTON 100

Bases de Cil. ALMA METAL
incluidas en las líneas
PREMIUM y PREMIUM C/O'RING

EQUIVALENTES	
YAMAHA: CRYPTON 105	

CODIGO	UNIDAD	MATERIAL
00421 P	JUEGO COMPLETO	PREMIUM
00421 P/O	JUEGO COMPLETO	PREMIUM C/O'RING
00845 P	CABEZA DE CILINDRO	PREMIUM
00845 P/O	CABEZA DE CILINDRO	PREMIUM C/O'RING
03850 A/M	BASE DE CILINDRO	ALMA METAL
03851 M	TAPA DE CILINDRO	METAL
03852	ESCAPE	CHAPA
03853 P	EMBRAGUE	PREMIUM
03854 P	ALTERNADOR	PREMIUM
03855 P	TENSOR CADENA	PREMIUM
03856	FILTRO ACEITE	ADAMITE
03857 P	ARANDELA	PREMIUM
24507 P	CARTER	PREMIUM
9-639	KIT O'RING COMPLETO	NITRILO
8-639	KIT O'RING CABEZA CIL.	NITRILO

00421 P - Juego completo

00845 P - Cabeza de Cilindro

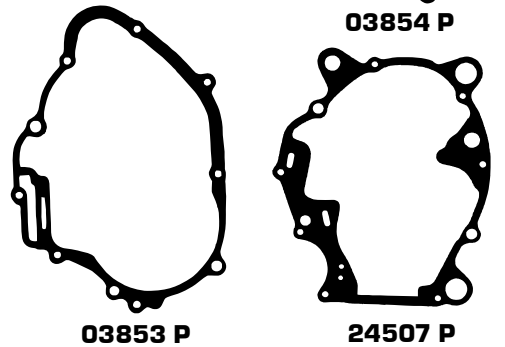
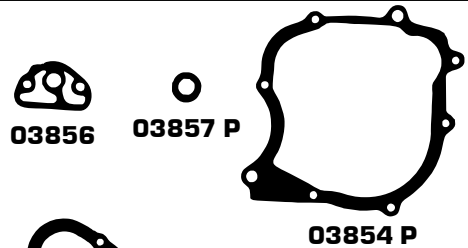
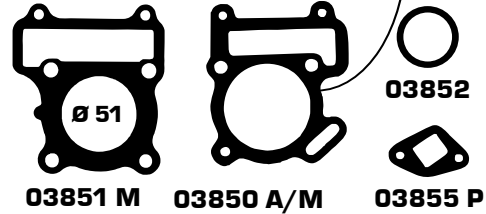

9-639 - Kit O'ring Completo

8-639 - Kit O'ring Cabeza Cil.

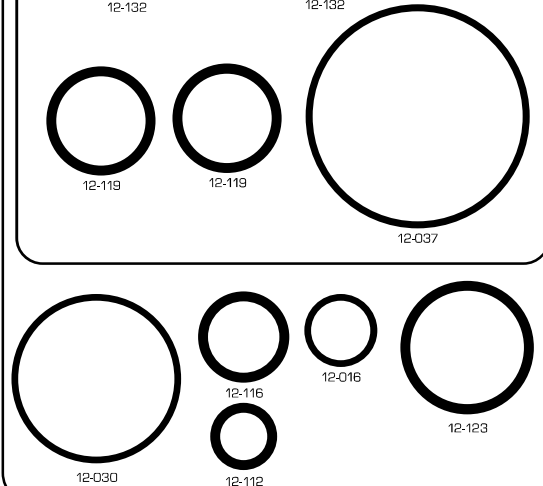
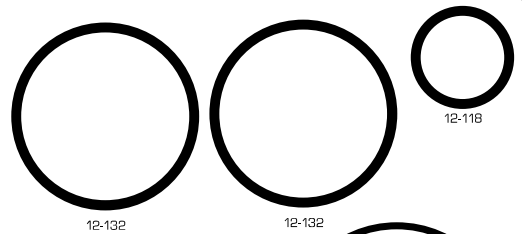

20240 P - YAMAHA NEW CRYPTON 110

Bases de Cil. ALMA METAL
incluidas en las líneas
PREMIUM y PREMIUM C/O RING

EQUIVALENTES

JIANSHE: JS 125 F (CUB)

CODIGO	UNIDAD	MATERIAL
20240 P	JUEGO COMPLETO	PREMIUM
20240 P/O	JUEGO COMPLETO	PREMIUM C/O RING
21240 P	CABEZA DE CILINDRO	PREMIUM
21240 P/O	CABEZA DE CILINDRO	PREMIUM C/O RING
03850 A/M	BASE DE CILINDRO	ALMA METAL
24449 M	TAPA DE CILINDRO	METAL
24449 A	TAPA DE CILINDRO	MFT
03852	ESCAPE	CHAPA
03853 P	EMBRAGUE	PREMIUM
03854 P	ALTERNADOR	PREMIUM
03855 P	TENSOR CADENA	PREMIUM
03856	FILTRO ACEITE	ADAMITE
03857 P	ARANDELA	PREMIUM
24507 P	CARTER	PREMIUM
9-639	KIT O RING COMPLETO	NITRILO
8-639	KIT O RING CABEZA CIL.	NITRILO

20240 P - Juego completo

21240 P - Cabeza de Cilindro

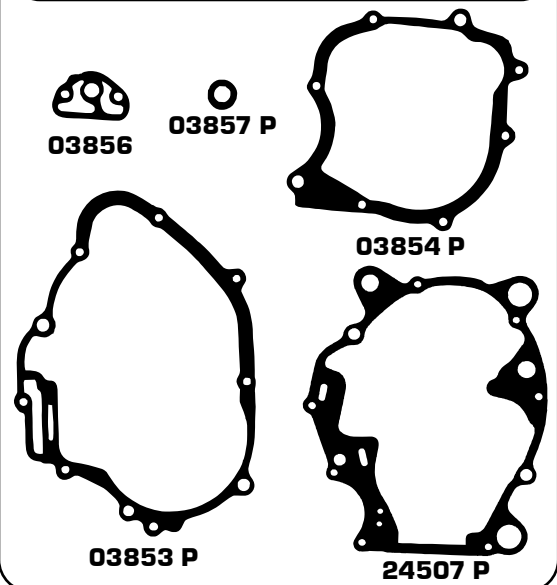
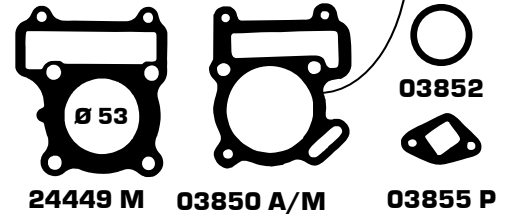

9-639 - Kit O ring Completo

8-639 - Kit O ring Cabeza Cil.

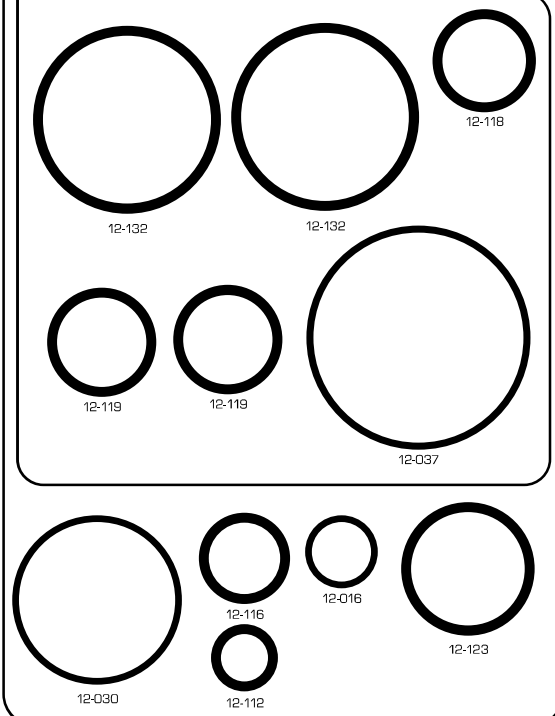



Motos y Cuatriciclos

06078 P - YAMAHA YBR 125

Bases de Cil. ALMA METAL
incluidas en las líneas
PREMIUM y PREMIUM C/O RING

EQUIVALENTES
JIANSHE: JS 125 6B STREET M. 2011/13
JINCHENG: 125 M.N.
YAMAHA: XTZ 125

CODIGO	UNIDAD	MATERIAL
06078 P	JUEGO COMPLETO	PREMIUM
06078 P/O	JUEGO COMPLETO	PREMIUM C/O RING
06341 P	CABEZA DE CILINDRO	PREMIUM
06341 P/O	CABEZA DE CILINDRO	PREMIUM C/O RING
07117 A/M	BASE DE CILINDRO	ALMA METAL
07118 M	TAPA DE CILINDRO	METAL
07118 A	TAPA DE CILINDRO	MFT
07119	ESCAPE	CHAPA
07120 P	EMBRAGUE	PREMIUM
07122 P	ALTERNADOR	PREMIUM
07123 P	TENSOR CADENA	PREMIUM
07124 P	ARANDELA	PREMIUM
07121	FILTRO ACEITE	ADAMITE
24506 P	CARTER	PREMIUM
25606	CUBA CARBURADOR	ADAMITE
9-634	KIT O RING COMPLETO	NITRILO
8-634	KIT O RING CABEZA CIL.	NITRILO

06078 P - Juego completo

06341 P - Cabeza de Cilindro

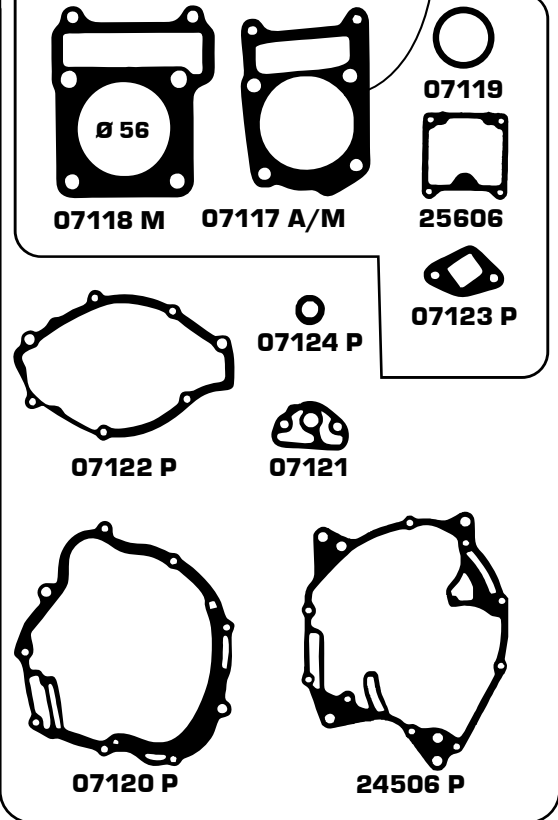

9-634 - Kit O ring Completo

8-634 - Kit O ring Cabeza Cil.

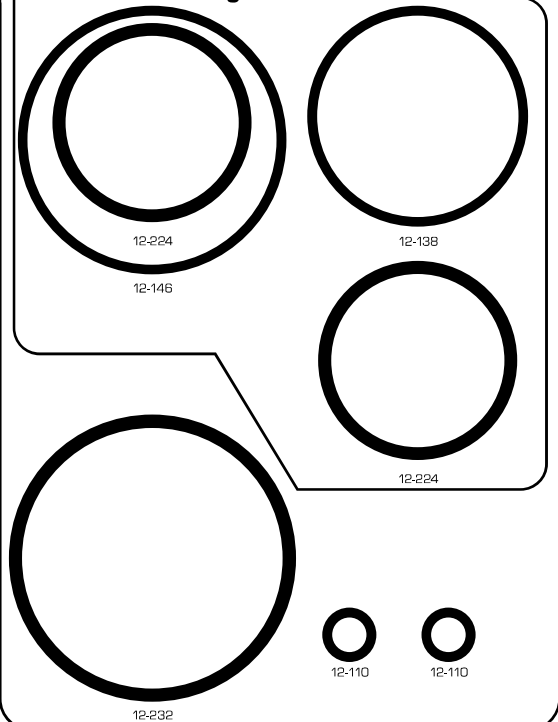



Motos y Cuatriciclos

20123 P - YAMAHA FZ 16 160

Bases de Cil. ALMA METAL
incluidas en las líneas
PREMIUM y PREMIUM C/O RING

EQUIVALENTES

CODIGO	UNIDAD	MATERIAL
20123 P	JUEGO COMPLETO	PREMIUM
20123 P/O	JUEGO COMPLETO	PREM. C/O RING
21123 P	CABEZA DE CILINDRO	PREMIUM
21123 P/O	CABEZA DE CILINDRO	PREM. C/O RING
23976 A/M	BASE DE CILINDRO	ALMA METAL
23977 M	TAPA DE CILINDRO	METAL
23977 A	TAPA DE CILINDRO	MFT
23978	ESCAPE	CHAPA
23979 P	EMBRAGUE	PREMIUM
23980 P	ALTERNADOR	PREMIUM
23981 P	RESPIRADERO	PREMIUM
24502 P	SALIDA DE GASES	PREMIUM
24491 P	ARBOL DE LEVAS	PREMIUM
23982 P	TENSOR CADENA	PREMIUM
12-7752	TAPA DE VÁLVULAS	NITRILO
9-640	KIT O RING COMPLETO	NITRILO
8-640	KIT O RING CABEZA CIL.	NITRILO

20123 P - Juego completo

21123 P - Cabeza de Cilindro

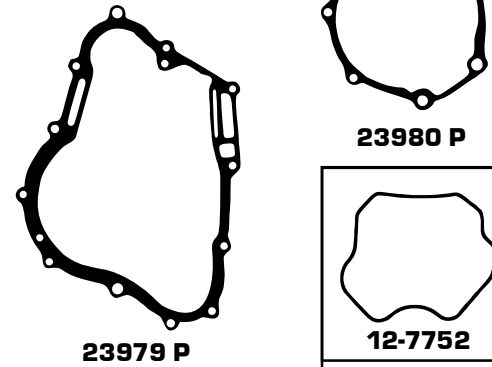
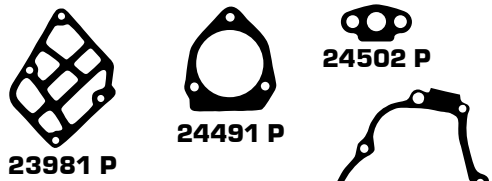
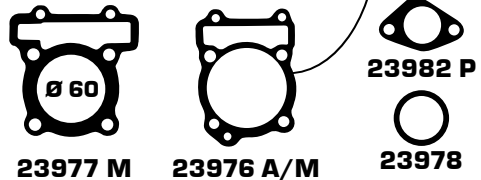

9-640 - Kit O ring Completo

8-640 - Kit O ring Cabeza Cil.

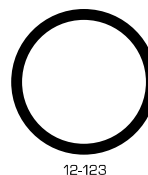
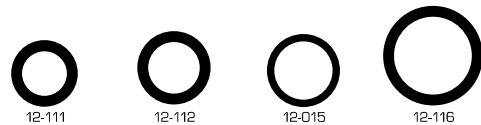
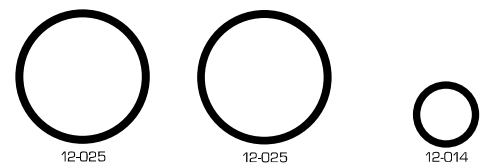

20100 P - YAMAHA YBR 250

Bases de Cil. ALMA METAL
incluidas en las líneas
PREMIUM y PREMIUM C/O RING

EQUIVALENTES	
YAMAHA: XTZ 250 - FAZER YS 250 - FZ 25 250	

CODIGO	UNIDAD	MATERIAL
20100 P	JUEGO COMPLETO	PREMIUM
20100 P/O	JUEGO COMPLETO	PREMIUM C/O RING
21102 P	CABEZA DE CILINDRO	PREMIUM
21102 P/O	CABEZA DE CILINDRO	PREMIUM C/O RING
23789 A/M	BASE DE CILINDRO	ALMA METAL
23790 M	TAPA DE CILINDR	METAL
23783	ESCAPE	CHAPA
23791 P	EMBRAGUE	PREMIUM
23794 P	BOMBA ACEITE	PREMIUM
23792 P	ALTERNADOR	PREMIUM
23793 P	TENSOR CADENA	PREMIUM
23795 P	ARBOL DE LEVAS	PREMIUM
24490 M	DRENAJE ACEITE	METAL
9-635	KIT O RING COMPLETO	NITRILO
8-635	KIT O RING CABEZA CIL.	NITRILO

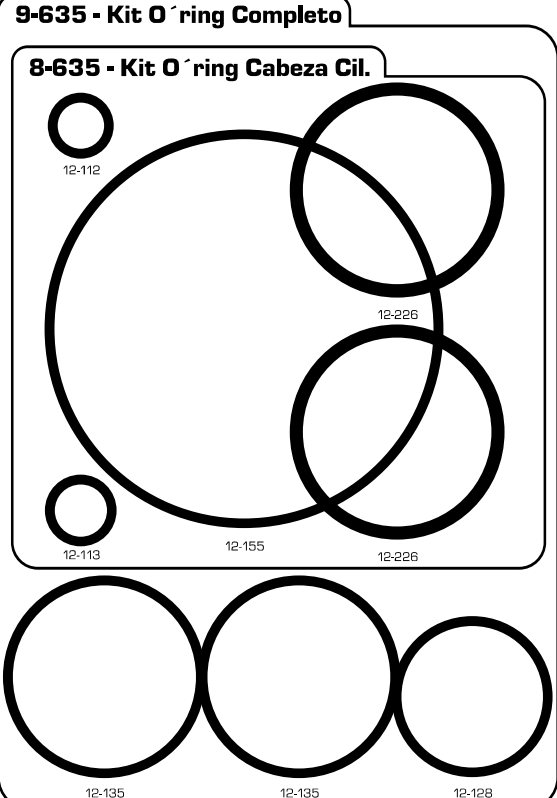
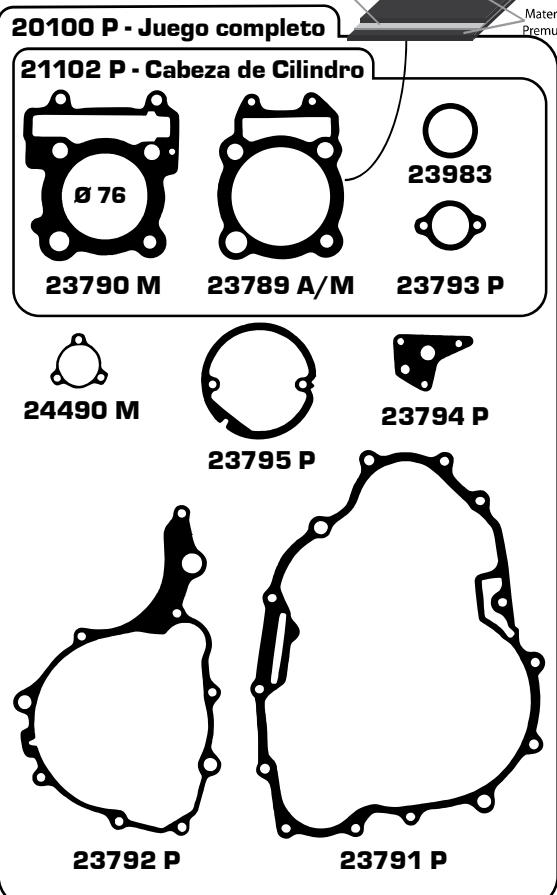

06182 P - ZANELLA 110 BUSINESS

EQUIVALENTES

GUERRERO: DAY 110

MOTOMEL: MAX 110

CODIGO	UNIDAD	MATERIAL
06182 P	JUEGO COMPLETO	PREMIUM
06182 P/O	JUEGO COMPLETO	PREMIUM C/O'RING
06458 P	CABEZA DE CILINDRO	PREMIUM
06458 P/O	CABEZA DE CILINDRO	PREMIUM C/O'RING
08834 A/M	BASE DE CILINDRO	ALMA METAL
08835 A	TAPA DE CILINDRO	MFT
08835 M	TAPA DE CILINDRO	METAL
08836	ESCAPE	CHAPA
08837 P	ADMISION AL CIL.	PREMIUM
08838 P	ADMISION AL CARB.	PREMIUM
08839 P	EMBRAGUE	PREMIUM
08840 P	CARTER	PREMIUM
08841	BOMBA ACEITE	ADAMITE
08842 P	ENCENDIDO	PREMIUM
08843 P	T/CABEZA DE CIL.	PREMIUM
08844 P	T/DISTRIBUCION	PREMIUM
08845 P	LATERAL DERECHO	PREMIUM
08950	FILTRO ACEITE	ADAMITE
08847 P	CENTRIFUGO ACEITE	PREMIUM
9-605	KIT O'RING COMPLETO	NITRILO
8-605	KIT O'RING CABEZA CIL.	NITRILO
9-638	KIT O'RING TAPA CIL.	NITRILO

06182 P - Juego completo

06458 P - Cabeza de Cilindro



08835 M



08834 A/M

Bases de Cil. ALMA METAL
incluidas en las líneas
PREMIUM y PREMIUM C/O' RING

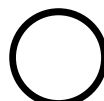

08844 P



08837 P



08838 P



08836



08845 P



08843 P



08950



08841



08847 P



08842 P

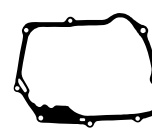

08839 P

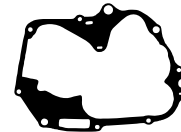

08840 P

9-605 - Kit O´ring Completo

8-605 - Kit O´ring Cabeza Cil.

9-638 - Kit O´ring Tapa de Cil.

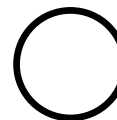
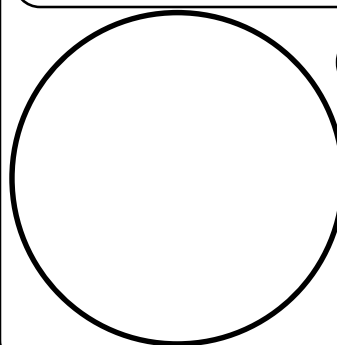
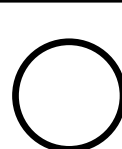
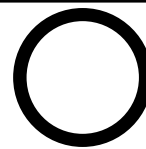
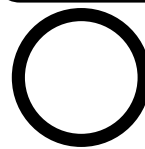

06204 P - ZANELLA ZB 110 (3 VÁLVULAS)

Bases de Cil. ALMA METAL incluidas en las líneas PREMIUM y PREMIUM C/O'RING

EQUIVALENTES	
MONDIAL: VENTO 110 3 VALV.	
ZANELLA: LD 110 3 VALV.	

CODIGO	UNIDAD	MATERIAL
06204 P	JUEGO COMPLETO	PREMIUM
06204 P/O	JUEGO COMPLETO	PREMIUM C/O'RING
06483 P	CABEZA DE CILINDRO	PREMIUM
06483 P/O	CABEZA DE CILINDRO	PREMIUM C/O'RING
22521 A/M	BASE DE CILINDRO	ALMA METAL
08917 A	TAPA DE CILINDRO	MFT
22522	ESCAPE	CHAPA
22523 P	VALVULA DE ADMISION	PREMIUM
22533 P	VALVULA DE ESCAPE	PREMIUM
22524 P	EMBRAGUE	PREMIUM
22525 P	CARTER	PREMIUM
22526	BOMBA ACEITE	ADAMITE
22527 P	ENCENDIDO	PREMIUM
22528 P	T/CABEZA DE CIL.	PREMIUM
22529 P	T/DISTRIBUCION	PREMIUM
22530 P	LATERAL DERECHO	PREMIUM
22531	FILTRO ACEITE	ADAMITE
22532 P	CENTRIFUGO ACEITE	PREMIUM
9-605	KIT O'RING COMPLETO	NITRILO
8-605	KIT O'RING CABEZA CIL.	NITRILO
9-638	KIT O'RING TAPA CIL.	NITRILO

06204 P - Juego completo

06483 P - Cabeza de Cilindro



08917 A

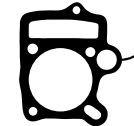

22521 A/M



22533 P



22523 P



22528 P



22530 P



22529 P



22522



22531



22526



22532 P



22527 P



22524 P

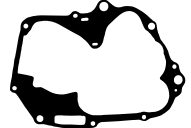

22525 P

9-605 - Kit O'ring Completo

8-605 - Kit O'ring Cabeza Cil.

9-638 - Kit O'ring Tapa de Cil.



12-7485



12-7486



12-7487



11-0303



12-217

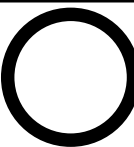

12-217

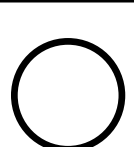

12-120

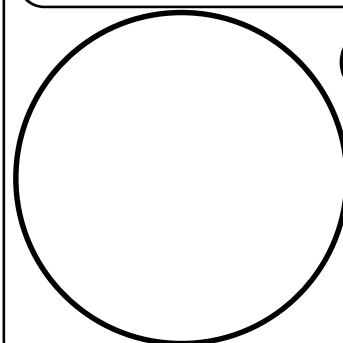

12-046



12-113



12-209



12-010



12-010

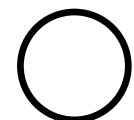

12-023

20064 P - ZANELLA ZB 125

EQUIVALENTES

ZANELLA: RACER 125

CODIGO	UNIDAD	MATERIAL
20064 P	JUEGO COMPLETO	PREMIUM
20064 P/O	JUEGO COMPLETO	PREMIUM C/O'RING
21025 P	CABEZA DE CILINDRO	PREMIUM
21025 P/O	CABEZA DE CILINDRO	PREMIUM C/O'RING
22561 A/M	BASE DE CILINDRO	ALMA METAL
22562 A	TAPA DE CILINDRO	MFT
22563	ESCAPE	CHAPA
22564 P	ADMISION AL CIL.	PREMIUM
22574 P	ADMISION AL CARB.	PREMIUM
22565 P	EMBRAGUE	PREMIUM
22566 P	CARTER	PREMIUM
22567	BOMBA ACEITE	ADAMITE
22568 P	ENCENDIDO	PREMIUM
22569 P	T/CABEZA DE CIL.	PREMIUM
22570 P	T/DISTRIBUCION	PREMIUM
22571 P	LATERAL DERECHO	PREMIUM
22572	FILTRO ACEITE	ADAMITE
22573 P	CENTRIFUGO ACEITE	PREMIUM
9-605	KIT O'RING COMPLETO	NITRILO
8-605	KIT O'RING CABEZA CIL.	NITRILO
9-638	KIT O'RING TAPA CIL.	NITRILO

20064 P - Juego completo

21025 P - Cabeza de Cilindro

Bases de Cil. ALMA METAL incluidas en las lineas PREMIUM y PREMIUM C/O'RING

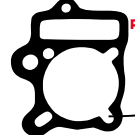

22562 A

22561 A/M

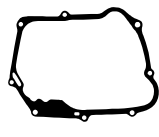
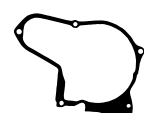
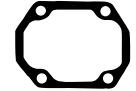
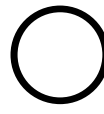

9-605 - Kit O'ring Completo

8-605 - Kit O'ring Cabeza Cil.

9-638 - Kit O'ring Tapa de Cil.

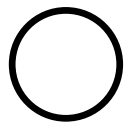
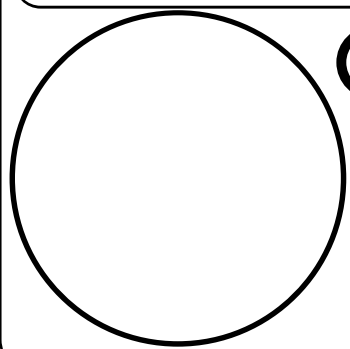
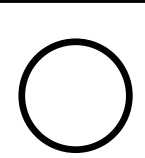
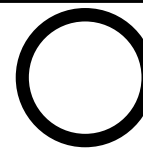
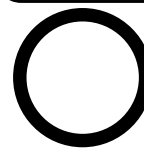

20459 P - ZANELLA CECATTO 150

Bases de Cil. ALMA METAL
incluidas en las líneas
PREMIUM y **PREMIUM C/O** RING

EQUIVALENTES

CODIGO	UNIDAD	MATERIAL
20459 P	JUEGO COMPLETO	PREMIUM
21459 P	CABEZA DE CILINDRO	PREMIUM
25370 A/M	BASE DE CILINDRO	ALMA METAL
25371 M	TAPA DE CILINDRO	METAL
25372 A	TAPA DE CILINDRO	MFT
25372	ESCAPE	CHAPA
25373 P	TENSOR CADENA	PREMIUM
25374 P	EMBRAGUE	PREMIUM
25375 P	CARTER	PREMIUM
25376 P	ENCENDIDO	PREMIUM
25377 P	CENTRIFUGO ACEITE	PREMIUM

20459 P - Juego Completo

21459 P - Cabeza de Cilindro

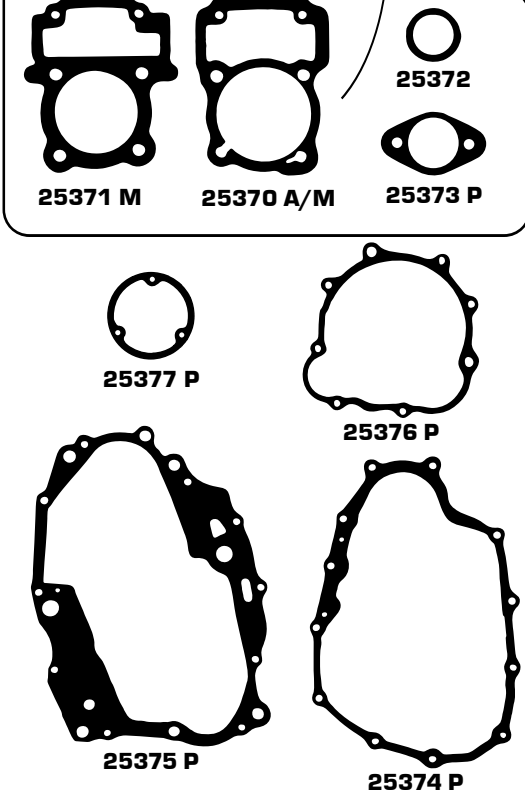



06188 P - ZANELLA RX 150

EQUIVALENTES
BRAVA: ELEKTRA 150 (VAR.) / CERRO: STREET 150
CORVEN: HUNTER 150 - TRIAX 150 / GILERA: VC STRADA 150
KELLER: KN STRATUS 150 / OKINOI: R - NAKED 150 - ST STREET 150
MAVERICK: STREET 150 / MOTOMEL: TCP 150 (VAR.) - GORILLA 150 (CUAT.)
SUMO: RAPID 150

CODIGO	UNIDAD	MATERIAL
06188 P	JUEGO COMPLETO	PREMIUM C/T. VALV.
06188 P/O	JUEGO COMPLETO	PREM. C/O'RING Y T/V
06464 P	CABEZA DE CILINDRO	PREMIUM
06464 P/O	CABEZA DE CILINDRO	PREM. C/O'RING Y T/V
23000 A/M	BASE DE CILINDRO	ALMA METAL
23001 A	TAPA DE CILINDRO	MFT
23001 M	TAPA DE CILINDRO	METAL
23002	ESCAPE	CHAPA
23003 P	ADMISION (2 X JGO)	PREMIUM
23004 p	EMBRAGUE	PREMIUM
23005 P	CARTER	PREMIUM
23006	BOMBA ACEITE	ADAMITE
23008 P	ENCENDIDO IZQ.	PREMIUM
23010 P	CENTRIFUGO ACEITE	PREMIUM
12-7545	TAPA VÁLVULAS	NITRILO
9-642	KIT O'RING COMPLETO	NITRILO
8-642	KIT O'RING CABEZA CIL.	NITRILO

06188 P - Juego completo

Bases de Cil. ALMA METAL
incluidas en las líneas
PREMIUM y PREMIUM C/O' RING

06464 P - Cabeza de Cilindro

23001 A **23000 A/M**
23002 **23003 P** **23003 P**
12-7545 **23006** **23010 P**
23008 P
23004 P **23005 P**

9-642 - Kit O'ring Completo

8-642 - Kit O'ring Cabeza Cil.

12-012 **12-012** **12-013** **12-114**
12-122 **12-115** **12-116** **12-218**
12-112 **12-112** **12-207** **12-209**
12-230 **12-121** **12-219**

20467 P - ZANELLA Z MAX TRUCK 200

Bases de Cil. ALMA METAL
incluidas en las líneas
PREMIUM y PREMIUM C/O RING

EQUIVALENTES

CODIGO	UNIDAD	MATERIAL
20467 P	JUEGO COMPLETO	PREMIUM
21467 P	CABEZA DE CILINDRO	PREMIUM
25345 A/M	BASE DE CILINDRO	ALMA METAL
25346 M	TAPA DE CILINDRO	METAL
25347	ESCAPE	CHAPA
25348 P	EMBRAGUE	PREMIUM
25349 P	CARTER	PREMIUM
25350 P	T/ENC. IZQ.	PREMIUM

20467 P - Juego Completo

21467 P - Cabeza de Cilindro

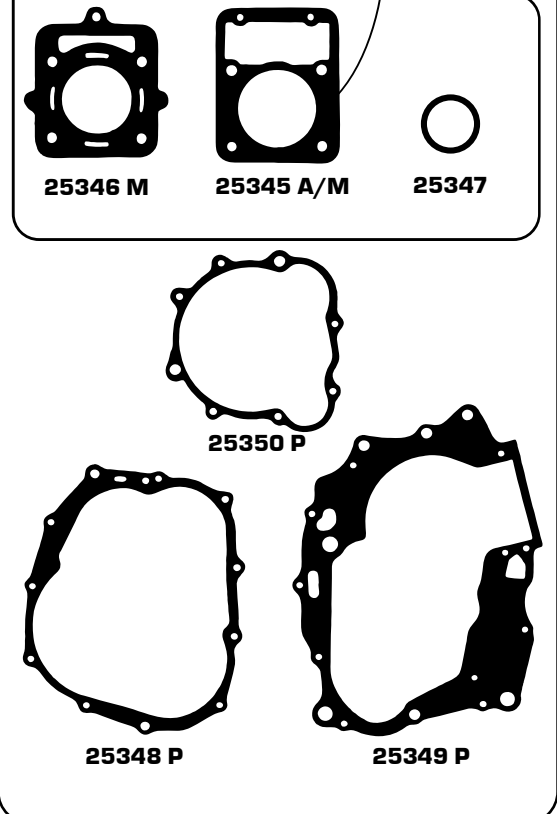

20505 P - ZANELLA ZR 200 OHC

Bases de Cil. ALMA METAL
incluidas en las líneas
PREMIUM y PREMIUM C/O' RING

EQUIVALENTES

CODIGO	UNIDAD	MATERIAL
20505 P	JUEGO COMPLETO	PREMIUM
20505 P/O	JUEGO COMPLETO	PREMIUM C/O' RING
21505 P	CABEZA DE CILINDRO	PREMIUM
21505 P/O	CABEZA DE CILINDRO	PREMIUM C/O' RING
25536 A/M	BASE DE CILINDRO	ALMA METAL
25536 P	BASE DE CILINDRO	PREMIUM
25537 M	TAPA DE CILINDRO	METAL
25538	ESCAPE	CHAPA
25539 P	TENSOR	PREMIUM
25540 P	EMBRAGUE	PREMIUM
25541 P	CARTER	PREMIUM
25543 P	T/ENC. IZQ.	PREMIUM
25544 A	ADMISION CHICA	MFT
25545 P	T/ARBOL DE LEVAS	PREMIUM
25546 P	T/CENT. ACEITE	PREMIUM
12-220	O' RING	NITRILO
9-614	KIT O' RING COMPLETO	NITRILO
8-614	KIT O' RING CABEZA CIL.	NITRILO

20505 P - Juego Completo

21505 P - Cabeza de Cilindro

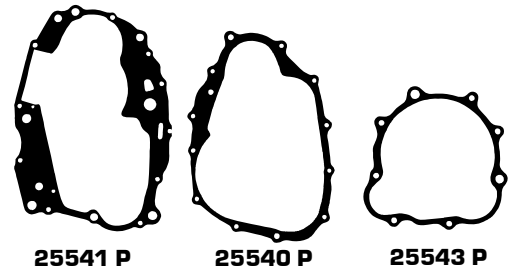
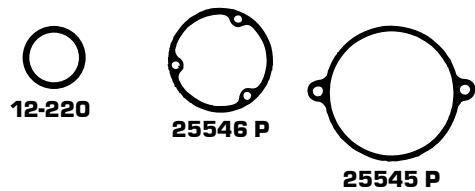
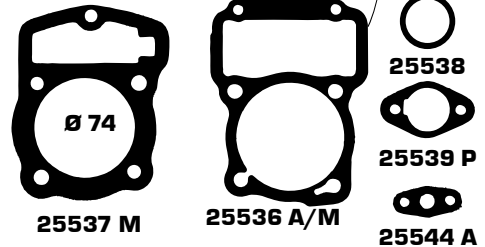

9-614 - Kit O' ring Completo

8-614 - Kit O' ring Cabeza Cil.

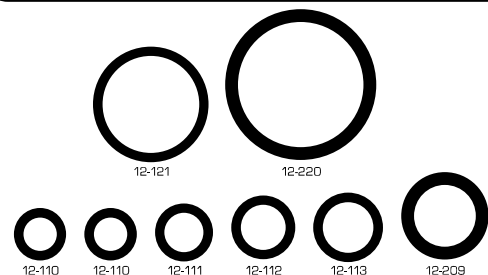
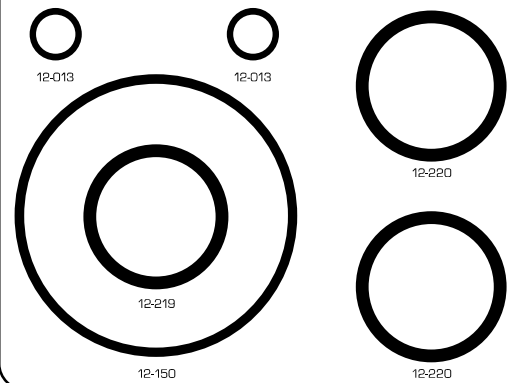

20420 P - ZANELLA STYLER 250

Bases de Cil. ALMA METAL
incluidas en las líneas
PREMIUM y PREMIUM C/O RING

EQUIVALENTES	

CODIGO	UNIDAD	MATERIAL
20420 P	JUEGO COMPLETO	PREMIUM
21420 P	CABEZA DE CILINDRO	PREMIUM
25440 A/M	BASE DE CILINDRO	ALMA METAL
25441 M	TAPA DE CILINDRO	METAL
25442	ESCAPE	CHAPA
25443 P	EMBRAGUE	PREMIUM
25444 P	ENCENDIDO	PREMIUM
25445 P	ENGRANAJE	PREMIUM

20420 P - Juego Completo

21420 P - Cabeza de Cilindro

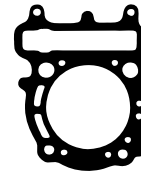

25441 M

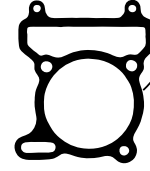

25440 A/M



25442 P



25445 P

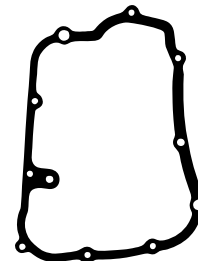

25444 P

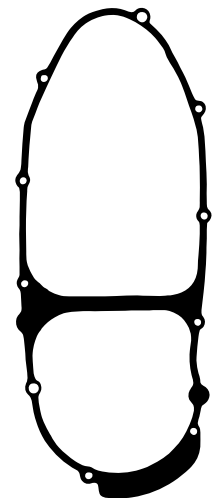

25443 P

